

EUROPEAN COMPLIANCE PROCESSES
(post RfG Implementation)

CONTENTS

(This contents page does not form part of the Grid Code)

Paragraph No/Title	Page No
ECP.1 INTRODUCTION.....	23
ECP.2 OBJECTIVE.....	34
ECP.3 SCOPE	34
ECP.4 CONNECTION PROCESS	4
ECP.5 ENERGISATION OPERATIONAL NOTIFICATION	56
ECP.6 OPERATIONAL NOTIFICATION PROCESSES	67
ECP.6.1 OPERATIONAL NOTIFICATION PROCESS (Type A)	67
ECP.6.2 INTERIM OPERATIONAL NOTIFICATION (Type B and Type C)	78
ECP.6.3 INTERIM OPERATIONAL NOTIFICATION (Type D and HVDC Equipment)	1142
ECP.7. FINAL OPERATIONAL NOTIFICATION.....	16
ECP.8 LIMITED OPERATIONAL NOTIFICATION	19
ECP.9 PROCESSES RELATING TO DEROGATIONS.....	23
ECP.10 MANUFACTURER'S DATA & PERFORMANCE REPORT	24
APPENDIX 1 NOT USED	27
APPENDIX 2 USER SELF CERTIFICATION OF COMPLIANCE (Interim/Final)	28
APPENDIX 3 SIMULATION STUDIES.....	29
APPENDIX 4 ONSITE SIGNAL PROVISION FOR WITNESSING TESTS.....	41
APPENDIX 5 COMPLIANCE TESTING OF SYNCHRONOUS POWER GENERATING MODULES	45
APPENDIX 6 COMPLIANCE TESTING OF POWER PARK MODULES.....	57
APPENDIX 7 70 COMPLIANCE TESTING FOR HVDC EQUIPMENT	70

EUROPEAN COMPLIANCE PROCESSES

ECP.1 INTRODUCTION

ECP.1.1 The **European Compliance Processes** ("ECP") specifies in relation to directly connected and **Embedded Power Stations** (subject to a **Bilateral Agreement**) and **HVDC Systems**:

(i) **Type A Power Generating Modules:**

the process for issuing and receiving an **Installation Document** which must be followed by **NGET** and any **User with a Type A Power Generating Module** to demonstrate its compliance with the **Grid Code** in relation to its **Plant** and **Apparatus** prior to the relevant **Plant** and **Apparatus** being energised.

(ii) ~~Type B or Type C or~~ **Power Generating Modules:**

~~the process (leading to a Preliminary Operational Notification and Final Operational Notification) which must be followed by NGET and any Generator to demonstrate its compliance with the Grid Code in relation to its Plant and Apparatus. This process shall be followed prior to and during the course of the relevant Plant and Apparatus being energised and Synchronised.~~

~~(iii)~~ **Type D Power Generating Modules and HVDC Systems:**

the process (leading to an **Energisation Operational Notification**) which must be followed by **NGET** and any **User with a Type B, Type C or Type D Power Generating Module or HVDC System** to demonstrate its compliance with the **Grid Code** in relation to its **Plant** and **Apparatus** (including any **OTSUA**) prior to the relevant **Plant** and **Apparatus** (including any **OTSUA**) being energised.

the process (leading to an **Interim Operational Notification** and **Final Operational Notification**) which must be followed by **NGET** and any **User with a Type B, Type C or Type D Power Generating Module or HVDC System Generator or HVDC System Owner** to demonstrate its compliance with the **Grid Code** in relation to its **Plant** and **Apparatus** (including and dynamically controlled **OTSUA**). This process shall be followed prior to and during the course of the relevant **Plant** and **Apparatus** (including **OTSUA**) being energised and **Synchronised**.

the process (leading to a **Limited Operational Notification**) which must be followed by **NGET** and each **Generator User with a Type B, Type C or Type D Power Generating Module or HVDC System and HVDC System Owner** where any of its **Plant** and/or **Apparatus** (including any **OTSUA**) becomes unable to comply with relevant provisions of the **Grid Code**, and where applicable with Appendices F1 to F5

Formatted: Tab stops: 2.5 cm, Left + Not at 2.75 cm

Formatted: Font: Bold

Formatted: Indent: Left: 1.27 cm, Hanging: 2.73 cm

Formatted: Indent: Hanging: 2.73 cm, Tab stops: 2.76 cm, Left + Not at 4 cm

Formatted: Indent: Left: 1.27 cm, Hanging: 2.73 cm

Formatted: Font: Not Bold

Formatted: Font: Bold

Formatted: Font: Bold

of the **Bilateral Agreement** (and in the case of **OTSUA** Appendices OF1 to OF5 of the **Bilateral Agreement**). This process also includes when changes or **Modifications** are made to **Plant** and/or **Apparatus** (including **OTSUA**). This process applies to such **Plant** and/or **Apparatus** after the **Plant** and/or **Apparatus** has become **Operational** and until **Disconnected** from the **Total System**, (or until, in the case of **OTSUA**, the **OTSUA Transfer Time**); when changes or **Modifications** are made.

ECP.1.2 As used in the **ECP** references to **OTSUA** means **OTSUA** to be connected or connected to the **National Electricity Transmission System** prior to the **OTSUA Transfer Time**.

ECP.1.3 Where ~~at~~ **the Generator** or **HVDC System Owner** and/or **NGET** are required to apply for a derogation to the **Authority**, this is not in respect of **OTSUA**.

ECP.2 OBJECTIVE

ECP.2.1 The objective of the **ECP** is to ensure that there is a clear and consistent process for demonstration of compliance by ~~User~~**EU Code Users** with the European Connection Conditions and **Bilateral Agreement** which are similar for all ~~Users~~**EU Code Users** of an equivalent category and will enable **NGET** to comply with its statutory and **Transmission Licence** obligations.

Formatted: Font: Bold

ECP.2.2 Provisions of the **ECP** which apply in relation to **OTSDUW** and **OTSUA** shall (in any particular case) apply up to the **OTSUA Transfer Time**, whereupon such provisions shall (without prejudice to any prior non-compliance) cease to apply.

ECP.2.3 In relation to **OTSDUW**, provisions otherwise to be contained in a **Bilateral Agreement** may be contained in the **Construction Agreement**, and accordingly a reference in the **ECP** to a relevant **Bilateral Agreement** includes the relevant **Construction Agreement**.

ECP.3 SCOPE

ECP.3.1 The **ECP** applies to **NGET** and to EU Code Users, which in the **ECP** means:

Formatted: Font: Bold

(a) **Generators** (other than in relation to **Embedded Power Stations** not subject to a **Bilateral Agreement**) including those undertaking **OTSDUW**.

Formatted: Indent: Left: 0 cm, Hanging: 3.81 cm

(b) **Network Operators**;

(c) **Non-Embedded Customers**;

(d) **HVDC System Owners** (other than those which only have **Embedded HVDC Systems** not subject to a **Bilateral Agreement**).

Formatted: List Paragraph, Indent: Left: 3.4 cm, First line: 0 cm

ECP.3.2 The above categories of **UserEU Code User** will become bound by the **ECP** prior to them generating, distributing, supplying or consuming, or in the case of **OTSUA**, transmitting, as the case may be, and references to the various categories should, therefore, be taken as referring to them in that prospective role as well as to **UserEU Code Users** actually connected.

Formatted: Font: Bold

ECP.4 **CONNECTION PROCESS**

ECP.4.1 The **CUSC Contract(s)** contain certain provisions relating to the procedure for connection to the **National Electricity Transmission System** or, in the case of **Embedded Power Stations** or **Embedded HVDC Systems**, becoming operational and include provisions to be complied with by **UserEU Code Users** prior to and during the course of **NGET** notifying the **UserEU Code User** that it has the right to become operational. In addition to such provisions this **ECP** sets out in further detail the processes to be followed to demonstrate compliance. While this **ECP** does not expressly address the processes to be followed in the case **OTSUA** connecting to a **Network Operator's User System** prior to **OTSUA Transfer Time**, the processes to be followed by **NGET** and the **Generator** in respect of **OTSUA** in such circumstances shall be consistent with those set out below by reference **OTSUA** directly connected to the **National Electricity Transmission System**.

Formatted: Font: Bold

ECP.4.2- The provisions contained in ECP.5 to ECP.7 detail the process to be followed in order for the **UserEU Code User's Plant and Apparatus** (including **OTSUA**) to become operational. This process includes

Formatted: Font: Bold

Formatted: Font: Bold

Formatted: List Paragraph, Numbered + Level: 1 + Numbering Style: i, ii, iii, ... + Start at: 1 + Alignment: Left + Aligned at: 2.75 cm + Indent at: 4.02 cm

(i) the acceptance of an **Installation Document for a Type A Power Generating Module**; This process includes

Formatted: Font: Bold

Formatted: List Paragraph, Indent: Left: 4.02 cm, First line: 0 cm

(ii) for energisation an **EON for Type B Type C or Type D Power Generating Modules** or **HVDC Equipment** (energisation);

Formatted: List Paragraph, Numbered + Level: 1 + Numbering Style: i, ii, iii, ... + Start at: 1 + Alignment: Left + Aligned at: 2.75 cm + Indent at: 4.02 cm

(iii) for synchronising an **IPON** for (Preliminary connection for **Type B Type C or Type DG Power Generating Modules or HVDC Equipment**) **ION** (interim synchronising) and;

Formatted: Indent: Left: 1.27 cm, No bullets or numbering, Tab stops: Not at 2.76 cm + 4.03 cm + 4.83 cm + 6.35 cm + 8.13 cm + 10.41 cm

(iv) for final certification a **FON** (final).

Formatted: List Paragraph, Numbered + Level: 1 + Numbering Style: i, ii, iii, ... + Start at: 1 + Alignment: Left + Aligned at: 2.75 cm + Indent at: 4.02 cm

ECP.4.2.1 The provisions contained in ECP.5 relate to the connection and energisation of **UserEU Code User's Plant and Apparatus** (including **OTSUA**) to the **National Electricity Transmission System** or where **Embedded**, to a **User's System**.

Formatted: Font: Bold

Formatted: Font: Not Bold

ECP.4.2.2 The provisions contained in ECP.6, ~~ECP.6A~~, ~~ECP.6B~~ and ECP.7 provide the process for **Generators** and **HVDC System Owners** to demonstrate compliance with the **Grid Code** and with, where applicable, the **CUSC Contract(s)** prior to and during the course of such **Generator's** or **HVDC System Owner's Plant and Apparatus** (including **OTSUA** up to the **OTSUA Transfer Time**) becoming operational.

Formatted: Indent: Left: 1.27 cm, No bullets or numbering, Tab stops: Not at 2.76 cm + 4.03 cm + 4.83 cm + 6.35 cm + 8.13 cm + 10.41 cm

Formatted: List Paragraph, Numbered + Level: 1 + Numbering Style: i, ii, iii, ... + Start at: 1 + Alignment: Left + Aligned at: 2.75 cm + Indent at: 4.02 cm

- ECP.4.2.3 The provisions contained in ECP.8 detail the process to be followed when:
- (a) a **Generator** or **HVDC System Owner's Plant** and/or **Apparatus** (including the **OTSUA**) is unable to comply with any provisions of the **Grid Code** and **Bilateral Agreement**; or,
 - (b) following any notification by a **Generator** or a **HVDC System Owner** under the **PC** of any change to its **Plant** and **Apparatus** (including any **OTSUA**); or,
 - (c) a **Modification** to a **Generator** or a **HVDC System Owner's Plant** and/or **Apparatus**.

ECP.4.3 **Embedded Medium Power Stations** not subject to a **Bilateral Agreement** and **Embedded HVDC Equipment** not subject to a **Bilateral Agreement**

ECP.4.3.1 In the case of ~~an~~ **Embedded Medium Power Stations** not subject to a **Bilateral Agreement** and **Embedded HVDC Equipment Stations Systems** not subject to a **Bilateral Agreement**, ensuring the obligations of the **ECC** and Appendix E of the relevant **Bilateral Agreement** between **NGET** and the host **Network Operator** are performed and discharged by the relevant party. For the avoidance of doubt the process in this **ECP** does not apply to ~~an~~ **Embedded Medium Power Stations** not subject to a **Bilateral Agreement** and **Embedded HVDC Equipment** not subject to a **Bilateral Agreement**.

Formatted: Font: Bold

ECP.5 **ENERGISATION OPERATIONAL NOTIFICATION**

Formatted: Font: Not Bold

Formatted: Underline

ECP.5.1 The following provisions apply in relation to the issue of an **Energisation Operational Notification** in respect of a **Power Station** consisting of **Type B, Type C or Type D Power Generating Modules** or an **HVDC System**.

Formatted: Font: Bold

ECP.5.1.1 Certain provisions relating to the connection and energisation of the ~~User~~ **EU Code User's Plant** and **Apparatus** at the **Connection Site** and **OTSUA** at the **Transmission Interface Point** and in certain cases of **Embedded Plant** and **Apparatus** are specified in the **CUSC** and/or **CUSC Contract(s)**. For other **Embedded Plant** and **Apparatus** the **Distribution Code**, the **DCUSA** and the **Embedded Development Agreement** for the connection specify equivalent provisions. Further detail on this is set out in ECP.5 below.

ECP.5.2 The items for submission prior to the issue of an **Energisation Operational Notification** are set out in ECC.5.2

ECP.5.3 In the case of a **Generator** or **HVDC System Owner** the items referred to in ECC.5.2 shall be submitted using the **Power Generating Module Document or User Data File Structure as applicable.**

Formatted: Font: Bold

ECP.5.4 Not less than 28 days, or such shorter period as may be acceptable in **NGET's** reasonable opinion, prior to the **EU Code User** wishing to energise its **Plant** and **Apparatus** (including passive **OTSUA**) for the first time the **EU Code User** will submit to

NGET a Certificate of Readiness to Energise **High Voltage** Equipment which specifies the items of **Plant** and **Apparatus** (including **OTSUA**) ready to be energised in a form acceptable to **NGET**.

ECP.5.5 If the relevant obligations under the provisions of the **CUSC** and/or **CUSC Contract(s)** and the conditions of ECP.5 have been completed to **NGET's** reasonable satisfaction then **NGET** shall issue an **Energisation Operational Notification**. Any dynamically controlled reactive compensation **OTSUA** (including Statcoms or Static Var Compensators) shall not be **Energised** until the appropriate **Interim Operational Notification** has been issued in accordance with ECP.6.

ECP.6 OPERATIONAL NOTIFICATION PROCESSES

ECP.6.1A OPERATIONAL NOTIFICATION PROCESS (Type A)

ECP.6.1.1A The following provisions apply in relation to the notification process in respect of a **Power Station** consisting of **Type A Power Generating Modules**.

ECP.6.1.2A Not less than 7 days, or such shorter period as may be acceptable in **NGET's** reasonable opinion, prior to the **Generator** wishing to **Synchronise** its **Plant** and **Apparatus** for the first time the **Generator** will:

- (i) submit to **NGET** a **Notification of the User's Intention to Connect**; and
- (ii) submit to **NGET** an **Installation Document** containing at least but not limited to the items referred to at ECP.6.1.3A.

ECP.6.1.3A Items for submission prior to connection.

ECP.6.1.3.1A Prior to the issue of an acknowledgment to connect the **Generator** must submit to **NGET** to **NGET's** satisfaction an **Installation Document** containing at least but not limited to:

- (i) The location at which the connection is made;
- (ii) The date of the connection;
- (iii) The maximum capacity of the installation in kW;
- (iv) The type of primary energy source;
- (v) The classification of the **Power Generating Module** as an emerging technology;
- (vi) A list of references to **Equipment Certificates** issued by an authorised certifier or otherwise agreed with **NGET** used for equipment that is installed at the site or copies of the relevant **Equipment Certificates** issued by an **Authorised**

Formatted: Font: Not Bold

Formatted: Default Paragraph Font

Formatted: Normal, Indent: First line: 0 cm, Tab stops: Not at 2.75 cm

Formatted: Font: Not Bold

Formatted: Font: Bold

Formatted: Font: Bold

Certifier or otherwise where these are relied upon as part of the evidence of compliance;

Formatted: Font: Bold

- (vii) As regards equipment used, for which an **Equipment Certificate** has not been received, information shall be provided as directed by ~~the~~ **NGET** or the **Relevant Network Operator**; and
- (viii) The contact details of the **Generator** and the installer and their signatures.

ECP.66.1.3.2A The items referred to in ECP.66.1.3A shall be submitted by the **Generator** in the form of an **Installation Document** for each applicable **Power Generating Module**.

ECP.66.1.4A No **Power Generating Module** shall be **Synchronised** to the **Total System** until the later of:

- (a) the date specified by the **Generator** in the **Installation Document** issued in respect of each applicable **Power Generating Module(s)**; and,
- (b) acknowledgement is received from **NGET** confirming receipt of the **Installation Document**.

ECP.66.1.5A When the requirements of ECP.66.1.2A to ECP.66.1.4A have been met, **NGET** will notify the **Generator** that the **Power Generating Module** may (subject to the **Generator** having fulfilled the requirements of ECP.6.1.3 where that applies) be **Synchronised** to the **Total System**.

ECP.66.1.6A Not less than 7 days, or such shorter period as may be acceptable in **NGET's** reasonable opinion, prior to the **Generator** wishing to decommission its **Plant** and **Apparatus** the **Generator** will:

(iii) submit to **NGET** a **Notification of User's Intention to Disconnect**.

Formatted: Indent: Left: 0 cm, Hanging: 2.54 cm

Formatted: Indent: Left: 0 cm, Hanging: 2.54 cm, No bullets or numbering, Tab stops: Not at 6.63 cm

ECP.66.2B ~~PRELIMINARY/INTERIM~~ OPERATIONAL NOTIFICATION (Type B and Type C)

Formatted: Indent: Left: 0 cm, Hanging: 2.54 cm

ECP.6.2.1B The following provisions apply in relation to the issue of a **Preliminary/Interim Operational Notification** in respect of a **Power Station** consisting of **Type B** and/or **Type C Power Generating Modules**.

Formatted: Font: Not Bold

ECP.66.2.2B Not less than 28 days, or such shorter period as may be acceptable in **NGET's** reasonable opinion, prior to the **Generator** wishing to **Synchronise** its **Plant** and **Apparatus** or dynamically controlled **OTSUA** for the first time the **Generator** or **HVDC Equipment** owner will:

(iv)(iii) submit to **NGET** a **Notification of User's Intention to Synchronise**; and

(iv) submit to **NGET** an initial **Power Generating Module Document** containing at least but not limited to the items referred to at ECP.66.2.3B.

ECP.66.2.3B Items for submission prior to issue of the **Preliminary Interim Operational Notification**.

ECP.66.2.3.1B Prior to the issue of a **Preliminary Interim Operational Notification** in respect of the **User EU Code User's Plant** and **Apparatus** or dynamically controlled **OTSUA** the **Generator** must submit to **NGET** to **NGET's** satisfaction a **preliminary Interim Power Generating Module Document** containing at least but not limited to:

- (i) updated **Planning Code** data (both **Standard Planning Data** and **Detailed Planning Data**), with any estimated values assumed for planning purposes confirmed or, where practical, replaced by validated actual values and by updated estimates for the future and by updated forecasts for **Forecast Data** items such as **Demand**;
- (ii) for **Type C Power Generating Modules** the simulation models;
- (iii) details of any special **Power Generating Module(s)** protection ~~as required by ECC.6.2.2.3 as applicable~~. This may include Pole Slipping protection and islanding protection schemes as applicable;
- (iv) simulation study provisions of Appendix ECP.A.3 and the results demonstrating compliance with **Grid Code** requirements of:

PC.A.5.4.2
PC.A.5.4.3.2,
ECC.6.3.4,
ECC.6.3.7.3.1 to ECC.6.3.7.3.6,
ECC.6.3.15, ECC.6.3.16
ECC.A.6.2.5.6
ECC.A.7.2.3.1

as applicable to the **Power Generating Module(s)** or dynamically controlled **OTSUA** unless agreed otherwise by **NGET**;

- (v) a detailed schedule of the tests and the procedures for the tests required to be carried out by the **Generator** under ECP.7.2 to demonstrate compliance with relevant **Grid Code** requirements. Such schedule to be consistent with Appendix ECP.A.5 (in the case of a **Synchronous Power Generating Module**) or Appendix ECP.A.6 (in the case of a **Power Park Modules**) and **OTSUA** as applicable);

- (vi) copies of **Manufacturer's Test Certificates** or **Equipment Certificates** issued by an **Authorised Certifier** or equivalent as agreed with **NGET** where these are relied upon as part of the evidence of compliance and
- (vii) a **Compliance Statement** and a **User Self Certification of Compliance** completed by the **User/EU Code User** (including any **Unresolved Issues**) against the relevant **Grid Code** requirements including details of any requirements that the **Generator** has identified that will not or may not be met or demonstrated.

ECP.66.2.3.2B The items referred to in ECP.66.2.3B shall be submitted by the **Generator** in the form of a **Power Generating Module Document (PGMD)** for each applicable **Power Generating Module**.

ECP.66.2.4B No **Generating Unit** or dynamically controlled **OTSUA** shall be **Synchronised** to the **Total System** (and for the avoidance of doubt, dynamically controlled **OTSUA** will not be able to transmit)– until the later of:

- (a) the date specified by **NGET** in the **Preliminary/Interim Operational Notification** issued in respect of each applicable **Power Generating Module(s)** or dynamically controlled **OTSUA**; and,
- (b) in the case of **Synchronous Power Generating Module(s)** only after the date of receipt by the **Generator** of written confirmation from **NGET** that the **Synchronous Power Generating Module** or **CCGT Module** as applicable has completed the following tests to demonstrate compliance with the relevant provisions of the **Connection Conditions** to **NGET's** satisfaction:
 - (i) those tests required to establish the open and short circuit saturation characteristics of the **Synchronous Power Generating Module** (as detailed in Appendix ECP.A.4.3) to enable assessment of the short circuit ratio in accordance with ECC.6.3.2. Such tests may be carried out at a location other than the **Power Station** site and supplied in the form of an **Equipment Certificate** or as otherwise agreed by **NGET**; and
 - (ii) open circuit step response tests (as detailed in Appendix ECP.A.5.2) to demonstrate compliance with ECC.A.6.2.4.1.

ECP.66.2.5B **NGET** shall assess the schedule of tests submitted by the **Generator** with the **Notification of User's Intention to Synchronise** under ECP.66.2.3B and shall determine whether such schedule has been completed to **NGET's** satisfaction.

ECP.66.2.6B When the requirements of ECP.66.2.2B to ECP.66.2.5B have been met, **NGET** will notify the **Generator** that the:
Synchronous Power Generating Module,

**CCGT Module,
Power Park Module or
Dynamically controlled OTSUA**

as applicable may (subject to the **Generator** having fulfilled the requirements of ECP.66.2.3B where that applies) be **Synchronised** to the **Total System** through the issue of an **PreliminaryInterim Operational Notification**. Where the **Generator** is undertaking **OTSDUW** then the **PreliminaryInterim Operational Notification** will be in two parts, with the "**PreliminaryInterim Operational Notification Part A**" applicable to **OTSUA** and the **PreliminaryInterim Operational Notification Part B**" applicable to the **UserEU Code Users Plant and Apparatus**. For the avoidance of doubt, the "**PreliminaryInterim Operational Notification Part A**" and the "**PreliminaryInterim Operational Notification Part B**" can be issued together or at different times. In respect of an **Embedded Power Station or Embedded HVDC Equipment Station** (other than a **Embedded Medium Power Stations** not subject to a **Bilateral Agreement** and **Embedded HVDC Equipment Stations** not subject to a **Bilateral Agreement**), **NGET** will notify the **Network Operator** that an **PreliminaryInterim Operational Notification** has been issued.

ECP.66.2.6.1B The **PreliminaryInterim Operational Notification** will be time limited, the expiration date being specified at the time of issue. The **PreliminaryInterim Operational Notification** may be renewed by **NGET**.

ECP.66.2.6.2B The **Generator** must operate the **Power Generating Module or OTSUA** in accordance with the terms, arising from the **Unresolved Issues**, of the **PreliminaryInterim Operational Notification**. Where practicable, **NGET** will discuss such terms with the **Generator** prior to including them in the **PreliminaryInterim Operational Notification**.

ECP.66.2.6.3B The **PreliminaryInterim Operational Notification** will include the following limitations:

- (a) In the case of **OTSUA**, the **PreliminaryInterim Operational Notification Part A** permits **Synchronisation** of the dynamically controlled **OTSUA** to the **Total System** only for the purposes of active control of voltage and reactive power and not for the purpose of exporting **Active Power**.
- (b) In the case of a **Power Park Module** the **PreliminaryInterim Operational Notification** (and where **OTSDUW Arrangements** apply, this reference will be to the **Interim Operational Notification Part B**) will limit the proportion of the **Power Park Module** which can be simultaneously **Synchronised** to the **Total System** such that neither of the following figures is exceeded:
 - (i) 20% of the **Maximum Capacity** of the **Power Park Module** (or the output of a single **Power Park Unit** where

this exceeds 20% of the **Power Station's Maximum Capacity**)

until the **Generator** has completed the voltage control tests (detailed in ECP.A.6.2) (including in respect of any dynamically controlled **OTSUA**) to **NGET's** reasonable satisfaction. Following successful completion of this test each additional **Power Park Unit** should be included in the voltage control scheme as soon as is technically possible (unless **NGET** agrees otherwise).

(e) — not applicable

(cd) In the case of a **Synchronous Power Generating Module** employing a static **Excitation System** the **Preliminary Interim Operational Notification** (and where **OTSDUW Arrangements** apply, this reference will be to the **Interim Operational Notification Part B**) may, if applicable, limit the maximum **Active Power** output and **Reactive Power** output of the **Synchronous Power Generating Module** or **CCGT module** prior to the successful commissioning of the **Power System Stabiliser** to **NGET's** satisfaction, if applicable.

Formatted: Indent: Left: 0 cm, First line: 0 cm

- | ECP.66.2.6.4B Operation in accordance with the **Preliminary Interim Operational Notification** whilst it is in force will meet the requirements for compliance by the **Generator** and **NGET** of all the relevant provisions of the **European Connection Conditions**.
- | ECP.66.2.7B Other than **Unresolved Issues** that are subject to tests required under ECP.7.2 to be witnessed by **NGET**, the **Generator** must resolve any **Unresolved Issues** prior to the commencement of the tests, unless **NGET** agrees to a later resolution. The **Generator** must liaise with **NGET** in respect of such resolution. The tests that may be witnessed by **NGET** are specified in ECP.7.2.
- | ECP.66.2.8B Not less than 28 days, or such shorter period as may be acceptable in **NGET's** reasonable opinion, prior to the **Generator** wishing to commence tests required under ECP.7 to be witnessed by **NGET**, the **Generator** will notify **NGET** that the **Power Generating Module(s)** as applicable is ready to commence such tests.
- | ECP.66.2.9B The items referred to at ECP.7.3 shall be submitted by the **Generator** after successful completion of the tests required under ECP.7.2.
- | ECP.66.3 INTERIM OPERATIONAL NOTIFICATION (Type D and HVDC Equipment)
- | ECP.66.3.1 The following provisions apply in relation to the issue of an **Interim Operational Notification** in respect of a **Power Station** consisting of **Type D Power Generating Modules** or an **HVDC System**.
- | ECP.66.3.2 Not less than 28 days, or such shorter period as may be acceptable in **NGET's** reasonable opinion, prior to the **Generator** or **HVDC System Owner** wishing to **Synchronise** its **Plant and Apparatus** or

Formatted: Font: Not Bold

Formatted: Font: Not Bold

dynamically controlled OTSUA for the first time the **Generator** or **HVDC System Owner** will:

- i. submit to **NGET** a **Notification of User's Intention to Synchronise**; and
- ii. submit to **NGET** the items referred to at ECP.66.3.3.

ECP.66.3.3 Items for submission prior to issue of the **Interim Operational Notification**.

ECP.66.3.3.1 Prior to the issue of an **Interim Operational Notification** in respect of the **User/EU Code User's Plant and Apparatus** or dynamically controlled **OTSUA** the **Generator** or **HVDC System Owner** must submit to **NGET** to **NGET's** satisfaction:

- (a) updated **Planning Code** data (both **Standard Planning Data** and **Detailed Planning Data**), with any estimated values assumed for planning purposes confirmed or, where practical, replaced by validated actual values and by updated estimates for the future and by updated forecasts for **Forecast Data** items such as **Demand**;
- (b) details of any special **Power Generating Module(s)** or **HVDC Equipment** protection as applicable. This may include Pole Slipping protection and islanding protection schemes;
- (c) any items required by ECP.5.2, updated by the **User/EU Code User** as necessary;
- (d) simulation study provisions of Appendix ECP.A.3 and the results demonstrating compliance with **Grid Code** requirements of:

PC.A.5.4.2
PC.A.5.4.3.2,
ECC.6.3.4,
ECC.6.3.7.3.1 to ECC.6.3.7.3.6,
ECC.6.3.15, **ECC.6.3.16**
ECC.A.6.2.5.6
ECC.A.7.2.3.1

as applicable to the **Power Station, Synchronous Power Generating Module(s), Power Park Module(s), HVDC Equipment** or dynamically controlled **OTSUA** unless agreed otherwise by **NGET**;

- (e) a detailed schedule of the tests and the procedures for the tests required to be carried out by the **Generator** or **HVDC System Owner** under ECP.7.2 to demonstrate compliance with relevant **Grid Code** requirements. Such schedule to be consistent with Appendix ECP.A.5 (in the case of **Synchronous Power Generating Modules**) or Appendix ECP.A.6 (in the case of **Power Park Modules** and **OTSUA**

as applicable) or Appendix ECP.A.7 (in the case of **HVDC Equipment**); and

- (f) an interim **Compliance Statement** and a **User Self Certification of Compliance** completed by the **User/EU Code User** (including any **Unresolved Issues**) against the relevant **Grid Code** requirements including details of any requirements that the **Generator** or **HVDC System Owner** has identified that will not or may not be met or demonstrated.

ECP.66.3.3.2 The items referred to in ECP.66.3.3 shall be submitted by the **Generator** or **HVDC System Owner** using the **User Data File Structure**.

ECP.66.3.4 No **Power Generating Module** or **HVDC Equipment** shall be **Synchronised** to the **Total System** (and for the avoidance of doubt, dynamically controlled **OTSUA** will not be able to transmit) until the later of:

- (a) the date specified by **NGET** in the **Interim Operational Notification** issued in respect of the **Power Generating Module(s)** or **HVDC Equipment** or dynamically controlled **OTSUA**; and,
- (b) if **Embedded**, the date of receipt of a confirmation from the **Network Operator** in whose **System** the **Plant and Apparatus** is connected that it is acceptable to the **Network Operator** that the **Plant and Apparatus** be connected and **Synchronised**; and,
- (c) in the case of **Synchronous Power Generating Module(s)** only after the date of receipt by **Generator** of written confirmation from **NGET** that the **Synchronous Power Generating Module** ~~or **CCGT Module** as applicable~~ has completed the following tests to demonstrate compliance with the relevant provisions of the **Connection Conditions** to **NGET's** satisfaction:
 - (i) those tests required to establish the open and short circuit saturation characteristics of the **Synchronous Power Generating Module** (as detailed in Appendix ECP.A.5.3) to enable assessment of the short circuit ratio in accordance with ECC.6.3.2. Such tests may be carried out at a location other than the **Power Station** site; and
 - (ii) open circuit step response tests (as detailed in Appendix ECP.A.5.2) to demonstrate compliance with ECC.A.6.2.4.1.

ECP.66.3.5 **NGET** shall assess the schedule of tests submitted by the **Generator** or **HVDC System Owner** with the **Notification of User's Intention to Synchronise** under ECP.66.3.1 and shall determine whether such schedule has been completed to **NGET's** satisfaction.

- ECP.66.3.6 When the requirements of ECP.66.3.2 to ECP.66.3.5 have been met, **NGET** will notify the **Generator** or **HVDC System Owner** that the:
- Synchronous Power Generating Module,**
 - CCGT Module,**
 - Power Park Module**
- Dynamically controlled **OTSUA** or **HVDC Equipment,**
- as applicable may (subject to the **Generator** or **HVDC System Owner** having fulfilled the requirements of ECP.66.3.3 where that applies) be **Synchronised** to the **Total System** through the issue of an **Interim Operational Notification**. Where the **Generator** is undertaking **OTSDUW** then the **Interim Operational Notification** will be in two parts, with the “**Interim Operational Notification Part A**” applicable to **OTSUA** and the “**Interim Operational Notification Part B**” applicable to the **UserEU Code Users Plant and Apparatus**. For the avoidance of doubt, the “**Interim Operational Notification Part A**” and the “**Interim Operational Notification Part B**” can be issued together or at different times. In respect of an **Embedded Power Station or Embedded HVDC Equipment Station** (other than a **Embedded Medium Power Stations** not subject to a **Bilateral Agreement** and **Embedded HVDC Equipment Stations** not subject to a **Bilateral Agreement**), **NGET** will notify the **Network Operator** that an **Interim Operational Notification** has been issued.
- ECP.66.3.6.1 The **Interim Operational Notification** will be time limited, the expiration date being specified at the time of issue. The **Interim Operational Notification** may be renewed by **NGET** for up to a maximum of 24 months from the date of the first issue of the **Interim Operational Notification**. **NGET** may only issue an extension to an **Interim Operational Notification** beyond 24 months provided the **Generator** or **HVDC System Owner** has applied for a derogation for any remaining **Unresolved Issues** to the **Authority** as detailed in ECP.9.
- ECP.66.3.6.2 The **Generator** or **HVDC System Owner** must operate the **Power Generating Module** or **HVDC Equipment** in accordance with the terms, arising from the **Unresolved Issues**, of the **Interim Operational Notification**. Where practicable, **NGET** will discuss such terms with the **Generator** or **HVDC System Owner** prior to including them in the **Interim Operational Notification**.
- ECP.66.3.6.3 The **Interim Operational Notification** will include the following limitations:
- (a) In the case of **OTSUA**, the **Interim Operational Notification Part A** permits **Synchronisation** of the dynamically controlled **OTSUA** to the **Total System** only for the purposes of active control of voltage and reactive power and not for the purpose of exporting **Active Power**.
 - (b) In the case of a **Power Park Module** the **Interim Operational Notification** (and where **OTSDUW** Arrangements apply, this reference will be to the **Interim Operational Notification Part B**) will limit the proportion of the **Power Park Module** which

Formatted: Font: Bold

Formatted: Font: Bold

can be simultaneously **Synchronised** to the **Total System** such that neither of the following figures is exceeded:

- (i) 20% of the **Maximum Capacity** of the **Power Park Module** (or the output of a single **Power Park Unit** where this exceeds 20% of the **Power Station's Maximum Capacity**); nor
- (ii) 50MW

until the **Generator** has completed the voltage control tests (detailed in ECP.A.66.3.2) to **NGET's** reasonable satisfaction. Following successful completion of this test each additional **Power Park Unit** should be included in the voltage control scheme as soon as is technically possible (unless **NGET** agrees otherwise).

- (c) In the case of a **Power Park Module** with a **Maximum Capacity** greater or equal to 100MW, the **Interim Operational Notification** (and where **OTSDUW** Arrangements apply, this reference will be to the **Interim Operational Notification Part B**) will limit the proportion of the **Power Park Module** which can be simultaneously **Synchronised** to the **Total System** to 70% of **Maximum Capacity** until the **Generator** has completed the **Limited Frequency Sensitive Mode (LFSM-O)** control tests with at least 50% of the **Maximum Capacity** of the **Power Park Module** in service (detailed in ECP.A.66.3.3) to **NGET's** reasonable satisfaction.

Formatted: Font: Bold

Formatted: Font: Bold

- (d) In the case of a **Synchronous Power Generating Module** employing a static **Excitation System** or a **Power Park Module** employing a **Power System Stabiliser** the **Interim Operational Notification** (and where **OTSDUW** Arrangements apply, this reference will be to the **Interim Operational Notification Part B**) may if applicable limit the maximum **Active Power** output and **Reactive Power** output of the **Synchronous Power Generating Module** or **CCGT module** prior to the successful commissioning of the **Power System Stabiliser** to **NGET's** satisfaction.

Formatted: Font: Bold

ECP.66.3.6.4 Operation in accordance with the **Interim Operational Notification** whilst it is in force will meet the requirements for compliance by the **Generator** or **HVDC System Owner** and **NGET** of all the relevant provisions of the **European Connection Conditions**.

ECP.66.3.7 Other than **Unresolved Issues** that are subject to tests required under ECP.7.2 to be witnessed by **NGET**, the **Generator** or **HVDC System Owner** must resolve any **Unresolved Issues** prior to the commencement of the tests, unless **NGET** agrees to a later resolution. The **Generator** or **HVDC System Owner** must liaise with **NGET** in respect of such resolution. The tests that may be witnessed by **NGET** are specified in ECP.7.2.

ECP.66.3.8 Not less than 28 days, or such shorter period as may be acceptable in **NGET's** reasonable opinion, prior to the **Generator** or **HVDC**

System Owner wishing to commence tests required under ECP.7 to be witnessed by **NGET**, the **Generator** or **HVDC System Owner** will notify **NGET** that the **Power Generating Module(s)** or **HVDC Equipment(s)** as applicable is ready to commence such tests.

ECP.6.3.9 The items referred to at ECP.7.3 shall be submitted by the **Generator** or the **HVDC System Owner** after successful completion of the tests required under ECP.7.2.

ECP.7. FINAL OPERATIONAL NOTIFICATION

Formatted: Font: Not Bold

ECP.7.1 The following provisions apply in relation to the issue of a **Final Operational Notification** in respect of a **Power Station** consisting of **Type B, Type C** and **Type D Power Generating Modules** or an **HVDC System**.

ECP.7.2 Tests to be carried out prior to issue of the **Final Operational Notification**.

ECP.7.2.1 Prior to the issue of a **Final Operational Notification** the **Generator** or **HVDC System Owner** must have completed the tests specified in this ECP.7.2.2 to **NGET's** satisfaction to demonstrate compliance with the relevant **Grid Code** provisions.

ECP.7.2.2 In the case of any **Power Generating Module, OTSUA** (if applicable) or **HVDC Equipment** these tests will reflect the relevant technical requirements and will comprise one or more of the following:

- (a) Reactive capability tests to demonstrate that the **Power Generating Module, OTSUA** (if applicable) or **HVDC Equipment** can meet the requirements of ECC.6.3.2. These may be witnessed by **NGET** on site if there is no metering to the **NGET** Control Centre.
- (b) voltage control system tests to demonstrate that the **Power Generating Module, OTSUA** (if applicable) or **HVDC Equipment** can meet the requirements of ECC.6.3.6.3, ECC.6.3.8 and, in the case of **Power Park Module, OTSUA** (if applicable) and **HVDC Equipment**, the requirements of ECC.A.7 or ECC.A.8 and, in the case of **Synchronous Power Generating Module** and **CCGT Module**, the requirements of ECC.A.6, and any terms specified in the **Bilateral Agreement** as applicable. These tests may also be used to validate the **Excitation System** model (PC.A.5.3) or voltage control system model (PC.A.5.4) as applicable. These tests may be witnessed by **NGET**.
- (c) governor or frequency control system tests to demonstrate that the **Power Generating Module, OTSUA** (if applicable) or **HVDC Equipment** can meet the requirements of ECC.6.3.6.2, ECC.6.3.7, where applicable ECC.A.3, and BC.3.7. In the case of a **Type B Power Generating Module** only tests BC3 and BC4 in ECP.A.5.8 Figure 2 or ECP.A.6.6

Figure 2 must be completed. The results will also validate the **Mandatory Service Agreement** required by ECC.8.1. These tests may also be used to validate the **gGovernor model** (PC.A.5.3) or frequency control system model (PC.A.5.4) as applicable. These tests may be witnessed by **NGET**.

- (d) fault ride through tests in respect of a **Power Station** with a **Maximum Capacity** of 100MW or greater, comprised of one or more **Power Park Modules**, to demonstrate compliance with ECC.6.3.15, **ECC.6.3.16** and ECC.A.4. Where test results from a **Manufacturers Data & Performance Report** as defined in ECP.10 have been accepted this test will not be required.
- (e) any further tests reasonably required by **NGET** and agreed with the **UserEU Code User** to demonstrate any aspects of compliance with the **Grid Code** and the **CUSC Contracts**.

ECP.7.2.3 **NGET's** preferred range of tests to demonstrate compliance with the **ECCs** are specified in Appendix ECP.A.5 (in the case of **Synchronous Power Generating Modules**) or Appendix ECP.A.6 (in the case of a **Power Park Modules** or **OTSUA** (if applicable)) or Appendix ECP.A.7 (in the case of **HVDC Equipment** and are to be carried out by the **UserEU Code User** with the results of each test provided to **NGET**. The **UserEU Code User** may carry out an alternative range of tests if this is agreed with **NGET**. **NGET** may agree a reduced set of tests where there is a relevant **Manufacturers Data & Performance Report** as detailed in ECP.10 or an applicable **Equipment Certificate** has been accepted.

ECP.7.2.4 In the case of **Offshore Power Park Modules** which do not contribute to **Offshore Transmission Licensee Reactive Power** capability as described in ECC.6.3.2.5 or ECC.6.3.2.6 or Voltage Control as described in ECC.6.3.8.5 the tests outlined in ECP.7.2.2 (a) and ECP.7.2.2 (b) are not required. However, the offshore **Reactive Power** transfer tests outlined in ECP.A.5.8 shall be completed in their place.

ECP.7.2.5 Following completion of each of the tests specified in this ECP.7.2, **NGET** will notify the **Generator** or **HVDC System Owner** whether, in the opinion of **NGET**, the results demonstrate compliance with the relevant **Grid Code** conditions.

ECP.7.2.6 The **Generator** or **HVDC System Owner** is responsible for carrying out the tests and retains the responsibility for safety and personnel during the test.

ECP.7.3 Items for submission prior to issue of the **Final Operational Notification**

ECP.7.3.1 Prior to the issue of a **Final Operational Notification** the **Generator** or **HVDC System Owner** must submit to **NGET** to **NGET's** satisfaction:

- (a) updated **Planning Code** data (both **Standard Planning Data** and **Detailed Planning Data**), with validated actual values and updated estimates for the future including **Forecast Data** items such as **Demand**;
- (b) any items required by ECP.5.2 and ECP.6.2.3 or ECP.6.3.3B as applicable, updated by the **UserEU Code User** as necessary;
- (c) evidence to **NGET's** satisfaction that demonstrates that the controller models and/or parameters (as required under PC.A.5.3.2(c) option 2, PC.A.5.3.2(d) option 2, PC.A.5.4.2, and/or PC.A.5.4.3.2) supplied to **NGET** provide a reasonable representation of the behaviour of the **UserEU Code User's Plant and Apparatus** and **OTSUA** if applicable;
- (d) copies of **Manufacturer's Test Certificates** or **Equipment Certificates** issued by an **Authorised Certifier** or equivalent where these are relied upon as part of the evidence of compliance;
- (e) results from the tests required in accordance with ECP.7.2 carried out by the **Generator** to demonstrate compliance with relevant **Grid Code** requirements including the tests witnessed by **NGET**; and
- (f) the final **Compliance Statement** and a **User Self Certification of Compliance** signed by the **UserEU Code User** and a statement of any requirements that the **Generator** or **HVDC System Owner** has identified that have not been met together with a copy of the derogation in respect of the same from the **Authority**.

ECP.7.3.2 The items in ECP.7.3 should be submitted by the **Generator** (including in respect of any **OTSUA** if applicable) or **HVDC System Owner** using the **User Data File Structure**.

ECP.7.4 If the requirements of ECP.7.2 and ECP.7.3 have been successfully met, **NGET** will notify the **Generator** or **HVDC System Owner** that compliance with the relevant **Grid Code** provisions has been demonstrated for the **Power Generating Module(s)**, **OTSUA** if applicable or **HVDC Equipment** as applicable through the issue of a **Final Operational Notification**. In respect of an **Embedded Power Station** or **Embedded HVDC Equipment** other than an **Embedded Medium Power Stations** not subject to a **Bilateral Agreement** and **Embedded HVDC Equipment** not subject to a **Bilateral Agreement**, **NGET** will notify the **Network Operator** that a **Final Operational Notification** has been issued.

ECP.7.5 If a **Final Operational Notification** can-not be issued because the requirements of ECP.7.2 and ECP.7.3 have not been successfully met prior to the expiry of an **Preliminary Operational Notification** or **an Interim Operational Notification** then the **Generator** or **HVDC System Owner** (where licensed in respect of its activities) and/or

NGET shall apply to the **Authority** for a derogation. The provisions of ECP.9 shall then apply.

ECP.8 LIMITED OPERATIONAL NOTIFICATION

Formatted: Font: Not Bold, Underline

ECP.8.1 Following the issue of a **Final Operational Notification** for a **Power Station** consisting of **Type B, Type C or Type D Power Generating Module** or an **HVDC System** if:

- (i) the **Generator or HVDC System Owner** becomes aware, that its **Plant and/or Apparatus**² (including **OTSUA** if applicable) capability to meet any provisions of the **Grid Code**, or where applicable the **Bilateral Agreement** is not fully available then the **Generator or HVDC System Owner** shall follow the process in ECP.8.2 to ECP.8.11; or,
- (ii) a **Network Operator** becomes aware, that the capability of **Plant and/or Apparatus**² belonging to a **Embedded Power Station or Embedded HVDC Equipment Station** (other than a **Embedded Medium Power Stations** not subject to a **Bilateral Agreement** and **Embedded HVDC Equipment Stations** not subject to a **Bilateral Agreement**) is failing to meet any provisions of the **Grid Code**, or where applicable the **Bilateral Agreement** then the **Network Operator** shall inform **NGET** and **NGET** shall inform the **Generator or HVDC System Owner** and then follow the process in ECP.8.2 to ECP.8.11; or,
- (iii) **NGET** becomes aware through monitoring as described in OC5.4, that a **Generator or HVDC System Owner Plant and/or Apparatus**² (including **OTSUA** if applicable) capability to meet any provisions of the **Grid Code**, or where applicable the **Bilateral Agreement** is not fully available then **NGET** shall inform the other party. Where **NGET** and the **Generator or HVDC System Owner** cannot agree from the monitoring as described in OC5.4 whether the **Plant and/or Apparatus** (including **OTSUA** if applicable) is fully available and/or is compliant with the requirements of the **Grid Code** and where applicable the **Bilateral Agreement**, the parties shall first apply the process in OC5.5.1, before applying the process defined in ECP.8 (**LON**) if applicable. Where the testing instructed in accordance with OC.5.5.1 indicates that the **Plant and/or Apparatus** (including **OTSUA** if applicable) is not fully available and/or is not compliant with the requirements of the **Grid Code** and/or the **Bilateral Agreement**, or if the parties so agree, the process in ECP.8.2 to ECP.8.11 shall be followed.

ECP.8.2 Immediately upon a **Generator or HVDC System Owner** becoming aware that its **Power Generating Module, OTSUA** (if applicable) or **HVDC Equipment** as applicable may be unable to comply with certain provisions of the **Grid Code** or (where applicable) the **Bilateral Agreement**, the **Generator or HVDC System Owner** shall notify **NGET** in writing. Additional details of any operating restrictions or

changes in applicable data arising from the potential non-compliance and an indication of the date from when the restrictions will be removed and full compliance demonstrated shall be provided as soon as reasonably practical.

ECP.8.3 If the nature of any unavailability and/or potential non-compliance described in ECP.8.1 causes or can reasonably be expected to cause a material adverse effect on the business or condition of **NGET** or other **UserEU Code Users** or the **National Electricity Transmission System** or any **UserEU Code User Systems** then **NGET** may, notwithstanding the provisions of this ECP.8 follow the provisions of Paragraph 5.4 of the **CUSC**.

ECP.8.4 Except where the provisions of ECP.8.3 apply, where the restriction notified in ECP.8.2 is not resolved in 28 days then the **Generator** or **HVDC System Owner** with input from and discussion of conclusions with **NGET**, and the **Network Operator** where the **Synchronous Power Generating Module, CCGT Module, Power Park Module** or **Power Station** as applicable is **Embedded**, shall undertake an investigation to attempt to determine the causes of and solution to the non-compliance. Such investigation shall continue for no longer than 56 days. During such investigation the **Generator** or **HVDC System Owner** shall provide to **NGET** the relevant data which has changed due to the restriction in respect of ECP.7.3.1 as notified to the **Generator** or **HVDC System Owner** by **NGET** as being required to be provided.

ECP.8.5 Issue and Effect of LON

ECP.8.5.1 Following the issue of a **Final Operational Notification**, **NGET** will issue to the **Generator** or **HVDC System Owner** a **Limited Operational Notification** if:

- (a) by the end of the 56 day period referred to at ECP.8.4, the investigation has not resolved the non-compliance to **NGET's** satisfaction; or
- (b) **NGET** is notified by a **Generator** or **HVDC Equipment Systemation Owner** of a **Modification** to its **Plant** and **Apparatus** (including **OTSUA** if applicable); or
- (c) **NGET** receives a submission of data, or a statement from a **Generator** or **HVDC System Owner** indicating a change in **Plant** or **Apparatus** (including **OTSUA** if applicable) or settings (including but not limited to governor and excitation control systems) that may in **NGETs** reasonable opinion, acting in accordance with **Good Industry Practice** be expected to result in a material change of performance.

In the case of an **Embedded Generator** or **Embedded HVDC System Owner**, **NGET** will issue a copy of the **Limited Operational Notification** to the **Network Operator**.

ECP.8.5.2 The **Limited Operational Notification** will be time limited (in the case of **Type D** or **HVDC Systems** to expire no later than 12 months from

Formatted: Font: Bold

the start of the non-compliance or restriction or from reconnection following a change). **NGET** may agree a longer duration in the case of a **Limited Operational Notification** following a **Modification** or whilst the **Authority** is considering the application for a derogation in accordance with ECP.9.1.

ECP.8.5.3 The **Limited Operational Notification** will notify the **Generator** or **HVDC System Owner** of any restrictions on the operation of the **Synchronous Power Generating Module(s)**, **CCGT Module(s)**, **Power Park Module(s)**, **OTSUA** if applicable or **HVDC Equipment** and will specify the **Unresolved Issues**. The **Generator** or **HVDC System Owner** must operate in accordance with any notified restrictions and must resolve the **Unresolved Issues**.

ECP.8.5.4 The **UserEU Code User** and **NGET** will be deemed compliant with all the relevant provisions of the **Grid Code** provided operation is in accordance with the **Limited Operational Notification**, whilst it is in force, and that the provisions of and referred to in ECP.8 are complied with.

ECP.8.5.5 The **Unresolved Issues** included in a **Limited Operational Notification** will show the extent that the provisions of ECP.7.2 (testing) and ECP.7.3 (final data submission) shall apply. In respect of selecting the extent of any tests which may in **NGET's** view reasonably be needed to demonstrate the restored capability and in agreeing the time period in which the tests will be scheduled, **NGET** shall, where reasonably practicable, take account of the **Generator** or **HVDC System Owner's** input to contain its costs associated with the testing.

ECP.8.5.6 In the case of a change or **Modification** the **Limited Operational Notification** may specify that the affected **Plant** and/or **Apparatus** (including **OTSUA** if applicable) or associated **Synchronous Power Generating Module(s)** or **Power Park Unit(s)** must not be **Synchronised** until all of the following items, that in **NGET's** reasonable opinion are relevant, have been submitted to **NGET** to **NGET's** satisfaction:

- (a) updated **Planning Code** data (both **Standard Planning Data** and **Detailed Planning Data**);
- (b) details of any relevant special **Power Station**, **Synchronous Power Generating Module(s)**, **Power Park Module(s)**, **OTSUA** (if applicable) or **HVDC Equipment Station(s)** protection as applicable. This may include Pole Slipping protection and islanding protection schemes; and
- (c) simulation study provisions of Appendix ECP.A.3 and the results demonstrating compliance with **Grid Code** requirements relevant to the change or **Modification** as agreed by **NGET**; and
- (d) a detailed schedule of the tests and the procedures for the tests required to be carried out by the **Generator** or **HVDC Equipment Station** to demonstrate compliance with relevant **Grid Code** requirements as agreed by **NGET**. The schedule

of tests shall be consistent with Appendix ECP.A.5 or Appendix ECP.A.6 as appropriate; and

- (e) an interim **Compliance Statement** and a **User Self Certification of Compliance** completed by the **User** (including any **Unresolved Issues**) against the relevant **Grid Code** requirements including details of any requirements that the **Generator** or **HVDC System Owner** has identified that will not or may not be met or demonstrated; and
- (f) any other items specified in the **LON**.

ECP.8.5.7 The items referred to in ECP.8.5.6 shall be submitted by the **Generator** (including in respect of any **OTSUA** if applicable) or **HVDC System Owner** using the **User Data File Structure** or **Power Generation Module Document** as applicable.

ECP.8.5.8 In the case of **Synchronous Power Generating Module(s)** only, the **Unresolved Issues** of the **LON** may require that the **Generator** must complete the following tests to **NGET's** satisfaction to demonstrate compliance with the relevant provisions of the **CCs** prior to the **Synchronous Power Generating Module** being **Synchronised** to the **Total System**:

- (a) those tests required to establish the open and short circuit saturation characteristics of the **Synchronous Power Generating Module** (as detailed in Appendix ECP.A.5.3) to enable assessment of the short circuit ratio in accordance with ECC.6.3.2.3.4 or ECC.6.3.2.5. Such tests may be carried out at a location other than the **Power Station** site; and
- (b) open circuit step response tests (as detailed in Appendix ECP.A.5.2) to demonstrate compliance with ECC.A.6.2.4.1.

ECP.8.6 In the case of a change or **Modification**, not less than 28 days, or such shorter period as may be acceptable in **NGET's** reasonable opinion, prior to the **Generator** or **HVDC System Owner** wishing to **Synchronise** its **Plant** and **Apparatus** (including **OTSUA** if applicable) for the first time following the change or **Modification**, the **Generator** or **HVDC System Owner** will:

- (i) submit a **Notification of User's Intention to Synchronise**; and
- (ii) submit to **NGET** the items referred to at ECP.8.5.6.

ECP.8.7 Other than **Unresolved Issues** that are subject to tests to be witnessed by **NGET**, the **Generator** or **HVDC System Owner** must resolve any **Unresolved Issues** prior to the commencement of the tests, unless **NGET** agrees to a later resolution. The **Generator** or **HVDC System Owner** must liaise with **NGET** in respect of such resolution. The tests that may be witnessed by **NGET** are specified in ECP.7.2.2.

ECP.8.8 Not less than 28 days, or such shorter period as may be acceptable in **NGET's** reasonable opinion, prior to the **Generator** or **HVDC System Owner** wishing to commence tests listed as **Unresolved Issues** to be witnessed by **NGET**, the **Generator** or **HVDC System Owner** will notify **NGET** that the **Synchronous Power Generating Module(s)**, **CCGT Module(s)**, **Power Park Module(s)**, **OTSUA** if applicable or **HVDC Equipment** as applicable is ready to commence such tests.

ECP.8.9 The items referred to at ECP.7.3 and listed as **Unresolved Issues** shall be submitted by the **Generator** or the **HVDC System Owner** after successful completion of the tests.

ECP.8.10 Where the **Unresolved Issues** have been resolved a **Final Operational Notification** will be issued to the **UserEU Code User**.

ECP.8.11 If a **Final Operational Notification** has not been issued by **NGET** as referred to at ECP.8.5.2 (or where agreed following a **Modification** by the expiry time of the **LON**) then the **Generator** or **HVDC System Owner** (where licensed in respect of its activities) and **NGET** shall apply to the **Authority** for a derogation.

ECP.9 PROCESSES RELATING TO DEROGATIONS

ECP.9.1 Whilst the **Authority** is considering the application for a derogation, the ~~**Preliminary Operational Notification**~~, ~~**Interim Operational Notification**~~ or **Limited Operational Notification** will be extended to remain in force until the **Authority** has notified **NGET** and the **Generator** or **HVDC System Owner** of its decision. Where the **Generator** or **HVDC System Owner** is not licensed **NGET** may propose any necessary changes to the **Bilateral Agreement** with such unlicensed **Generator** or **HVDC System Owner**.

ECP.9.2 If the **Authority**:

- (a) grants a derogation in respect of the **Plant** and/or **Apparatus**, then **NGET** shall issue **Final Operational Notification** once all other **Unresolved Issues** are resolved; or
- (b) decides a derogation is not required in respect of the **Plant** and/or **Apparatus** then **NGET** will reconsider the relevant **Unresolved Issues** and may issue a **Final Operational Notification** once all other **Unresolved Issues** are resolved; or
- (c) decides not to grant any derogation in respect of the **Plant** and/or **Apparatus**, then there will be no **Operational Notification** in place and **NGET** and the **UserEU Code User** shall consider its rights pursuant to the **CUSC**.

ECP.9.3 Where a ~~**Preliminary Operational Notification**~~, ~~**Interim Operational Notification**~~ or **Limited Operational Notification** is so conditional upon a derogation and such derogation includes any conditions (including any time limit to such derogation) the **Generator** or **HVDC System Owner** will progress the resolution of any **Unresolved Issues** and / or progress and / or comply with any conditions upon such derogation and the provisions of ECP.6.9 to ECP.7.4 shall apply and shall be followed.

ECP.10 MANUFACTURER'S DATA & PERFORMANCE REPORT

ECP.10.1.1 Data and performance characteristics in respect of certain **Grid Code** requirements may be registered with **NGET** by **Power Park Unit** manufacturers in respect of specific models of **Power Park Units** by submitting information in the form of a **Manufacturer's Data and Performance Report** to **NGET**.

ECP.10.1.2 A **Generator** planning to construct a new **Power Station** containing the appropriate version of **Power Park Units** in respect of which a **Manufacturer's Data & Performance Report** has been submitted to **NGET** may reference the **Manufacturer's Data & Performance Report** in its submissions to **NGET**. Any **Generator** considering referring to a **Manufacturer's Data & Performance Report** for any aspect of its **Plant** and **Apparatus** may contact **NGET** to discuss the suitability of the relevant **Manufacturer's Data & Performance Report** to its project to determine if, and to what extent, the data included in the **Manufacturer's Data & Performance Report** contributes towards demonstrating compliance with those aspects of the **Grid Code** applicable to the **Generator**. **NGET** will inform the **Generator** if the reference to the **Manufacturer's Data & Performance Report** is not appropriate or not sufficient for its project.

ECP.10.1.3 The process to be followed by **Power Park Unit** manufacturers submitting a **Manufacturer's Data & Performance Report** is agreed by **NGET**. ECP.10.2 indicates the specific **Grid Code** requirement areas in respect of which a **Manufacturer's Data & Performance Report** may be submitted.

ECP.10.1.4 **NGET** will maintain and publish a register of those **Manufacturer's Data & Performance Reports** which **NGET** has received and accepted as being an accurate representation of the performance of the relevant **Plant** and / or **Apparatus**. Such register will identify the manufacturer, the model(s) of **Power Park Unit(s)** to which the report applies and the provisions of the **Grid Code** in respect of which the report contributes towards the demonstration of compliance. The inclusion of any report in the register does not in any way confirm that any **Power Park Modules** which utilise any **Power Park Unit(s)** covered by a report is or will be compliant with the **Grid Code**.

ECP.10.2 A **Manufacturer's Data & Performance Report** in respect of **Power Park Units** may cover one (or part of one) or more of the following provisions of the **Grid Code**:

(a) Fault Ride Through capability ECC.6.3.15, ECC.6.3.16.

Formatted: Font: Not Bold

(b) Power Park Module mathematical model PC.A.5.4.2.

Formatted: Font: Not Bold

ECP.10.3 Reference to a **Manufacturer's Data & Performance Report** in a **UserEU Code User's** submissions does not by itself constitute compliance with the **Grid Code**.

ECP.10.4 A **Generator** referencing a **Manufacturer's Data & Performance Report** should insert the relevant **Manufacturer's Data & Performance Report** reference in the appropriate place in the **DRC** data submission, **Power Generating Module Document** and / or in the **User Data File Structure**. **NGET** will consider the suitability of a **Manufacturer's Data & Performance Report**:

Formatted: Font: Bold

(a) in place of **DRC** data submissions a mathematical model suitable for representation of the entire **Power Park Module** as per ECP.A.3.4.4. For the avoidance of doubt only the relevant sections as specified in PC.A.2.5.5.7 apply. Site specific parameters will still need to be submitted by the **Generator**.

(b) in place of Fault simulation studies as follows;

NGET will not require Fault Ride Through simulation studies to be conducted as per ECP.A.3.5.1 and qualified in ECP.A.3.5.2 provided that;

(i) Adequate and relevant **Power Park Unit** data is included in respect of Fault Ride Through testing covered in ECP.A.6.7 in the relevant **Manufacturer's Data & Performance Report** , and

(ii) For each type and duration of fault as detailed in ECP.A.3.5.1, the expected minimum retained voltage is greater than the corresponding minimum voltage achieved and successfully ridden through in the fault ride through tests covered by the **Manufacturer's Data & Performance Report**.

(c) to reduce the scope of compliance site tests as follows;

(i) Where there is a **Manufacturer's Data & Performance Report** in respect of a **Power Park Unit** which covers Fault Ride Through, **NGET** may agree that no Fault Ride Through testing is required.

ECP.10.5 It is the responsibility of the **User/EU Code User** to ensure that the correct reference for the **Manufacturer's Data & Performance Report** is used and the **User/EU Code User** by using that reference accepts responsibility for the accuracy of the information. The **User/EU Code User** shall ensure that the manufacturer has kept **NGET** informed of any relevant variations in plant specification since the submission of the relevant **Manufacturer's Data & Performance Report** which could impact on the validity of the information.

ECP.10.6 **NGET** may contact the **Power Park Unit** manufacturer directly to verify the relevance of the use of such **Manufacturer's Data & Performance Report**. If **NGET** believe the use some or all of such **Manufacturer's Data & Performance Report** information is incorrect or the referenced data is inappropriate then the reference to the **Manufacturer's Data & Performance Report** may be declared

invalid by **NGET**. Where, and to the extent possible, the data included in the **Manufacturer's Data & Performance Report** is appropriate, the compliance assessment process will be continued using the data included in the **Manufacturer's Data & Performance Report**.

DRAFT

APPENDIX 1
NOT USED

DRAFT

APPENDIX 2

USER SELF CERTIFICATION OF COMPLIANCE (Interim/Final)

Power Station/ HVDC Equipment Station	[Name of Connection Site/site of connection]	User:	[Full User name]	Maximum Capacity (MW) of Plant:	
--	---	--------------	------------------	--	--

This **User Self Certification of Compliance** records the compliance by the **UserEU Code User** in respect of [NAME] **Power Station/HVDC Equipment Station** with the **Grid Code** and the requirements of the **Bilateral Agreement** and **Construction Agreement** dated [] with reference number []. It is completed by the **Power Station/HVDC System Owner** in the case of **Plant** and/or **Apparatus** connected to the **National Electricity Transmission System** and for **Embedded Plant**.

We have recorded our compliance against each requirement of the **Grid Code** which applies to the **Power Station/HVDC Equipment Station**, together with references to supporting evidence and a commentary where this is appropriate, and have provided this to **NGET**. A copy of the **Compliance Statement** is attached.

Supporting evidence, in the form of simulation results, test results, manufacturer's data and other documentation, is attached in the **User Data File Structure**.

The **UserEU Code User** hereby certifies that, to the best of its knowledge and acting in accordance with **Good Industry Practice**, the **Power Station** is compliant with the **Grid Code** and the **Bilateral Agreement** in all aspects [with the following **Unresolved Issues***] [with the following derogation(s)**]:

Connection Condition	Requirement	Ref:	Issue

Compliance certified by:	Name:	Title:
	[PERSON]	[PERSON DESIGNATION]
	Signature:	Of
	[PERSON]	[User details]
	Date:	

* Include for Interim User Self Certification of Compliance ahead of Interim Operational Notification.

** Include for final User Self Certification of Compliance ahead of Final Operational Notification where derogation(s) have been granted. If no derogation(s) required delete wording and Table.

APPENDIX 3

SIMULATION STUDIES

ECP.A.3.1 SCOPE

- ECP.A.3.1.1 This Appendix sets out the simulation studies required to be submitted to **NGET** to demonstrate compliance with the Connection Conditions unless otherwise agreed with **NGET**. This Appendix should be read in conjunction with ECP.6 with regard to the submission of the reports to **NGET**. Where there is any inconsistency in the technical requirements in respect of which compliance is being demonstrated by simulation in this Appendix and ECC.6.3 and the **Bilateral Agreement**, the provisions of the **Bilateral Agreement** and ECC.6.3 prevail. The studies specified in this Appendix will normally be sufficient to demonstrate compliance. However **NGET** may agree an alternative set of studies proposed by the **Generator** or **HVDC System Owner** provided **NGET** deem the alternative set of studies sufficient to demonstrate compliance with the **Grid Code** and the **Bilateral Agreement**.
- ECP.A.3.1.2 The **Generator** or **HVDC System Owner** shall submit simulation studies in the form of a report to demonstrate compliance. In all cases the simulation studies must utilise models applicable to the **Synchronous Power Generating Module**, **HVDC Equipment** or **Power Park Module** with proposed or actual parameter settings. Reports should be submitted in English with all diagrams and graphs plotted clearly with legible axes and scaling provided to ensure any variations in plotted values is clear. In all cases the simulation studies must be presented over a sufficient time period to demonstrate compliance with all applicable requirements.
- ECP.A.3.1.3 In the case of an **Offshore Power Station** where **OTSDUW Arrangements** apply simulation studies by the **Generator** should include the action of any relevant **OTSUA** where applicable to demonstrate compliance with the **Grid Code** and the **Bilateral Agreement** at the **Interface Point**.
- ECP.A.3.1.4 **NGET** will permit relaxation from the requirement ECP.A.3.2 to ECP.A.3.8 where an **Equipment Certificate** for the **Power Generating Module** or **HVDC Equipment** has been provided which details the characteristics from appropriate simulations on a representative installation with the same equipment and settings and the performance of the **Power Generating Module** or **HVDC Equipment** can, in **NGET's** opinion, reasonably represent that of the installed **Power Generating Module** or **HVDC Equipment**.
- ECP.A.3.1.5 For **Type B**, **Type C** and **Type D Power Generating Modules** the relevant **Equipment Certificate** must be supplied in the **Power Generating Module Document** or **Users Data File structure** as applicable. For **HVDC Equipment** the relevant **Equipment Certificates** must be supplied in the **Users Data File structure**.

ECP.A.3.2 Power System Stabiliser Tuning

Formatted: Default Paragraph Font, Font: Arial, 11 pt, No underline

Formatted: Normal, Left

Formatted: Underline

Formatted: Justified

ECP.A.3.2.1 In the case of a **Synchronous Power Generating Module** with an **Excitation System Power System Stabiliser** the **Power System Stabiliser** tuning simulation study report required by ECC.A.6.2.5.6 or required by the **Bilateral Agreement** shall contain:

- (i) the **Excitation System** model including the **Power System Stabiliser** with settings as required under the **Planning Code** (PC.A.5.3.2(c))
- (ii) open circuit time series simulation study of the response of the **Excitation System** to a +10% step change from 90% to 100% terminal voltage.
- (iii) on load time series dynamic simulation studies of the response of the **Excitation System** with and without the **Power System Stabiliser** to 2% and 10% steps in the reference voltage and a three phase short circuit fault applied to the higher voltage side of the **Synchronous Power Generating Module** transformer for 100ms. The simulation studies should be carried out with the **Synchronous Power Generating Module** operating at full **Active Power** and maximum leading **Reactive Power** import with the fault level at the **Supergrid** HV connection point at minimum or as otherwise agreed with **NGET**. The results should show the **Synchronous Power Generating Module** field voltage, terminal voltage, **Power System Stabiliser** output, **Active Power** and **Reactive Power** output.
- (iv) gain and phase Bode diagrams for the open loop frequency domain response of the **Synchronous Power Generating Module Excitation System** with and without the **Power System Stabiliser**. These should be in a suitable format to allow assessment of the phase contribution of the **Power System Stabiliser** and the gain and phase margin of the **Excitation System** with and without the **Power System Stabiliser** in service.
- (v) an eigenvalue plot to demonstrate that all modes remain stable when the **Power System Stabiliser** gain is increased by at least a factor of 3 from the designed operating value.
- (vi) gain Bode diagram for the closed loop on load frequency domain response of the **Synchronous Power Generating Module Excitation System** with and without the **Power System Stabiliser**. The **Synchronous Power Generating Module** operating at full load and at unity power factor. These diagrams should be in a suitable format to allow comparison of the **Active Power** damping across the frequency range specified in ECC.A.6.2.6.3 with and without the **Power System Stabiliser** in service.

ECP.A.3.2.2 In the case of **Onshore Non-Synchronous Power Generating Module, Onshore HVDC Equipment** and **Onshore Power Park Modules** and **OTSDUW Plant** and

Apparatus at the **Interface Point** the **Power System Stabiliser** tuning simulation study report required by ECC.A.7.2.4.1 or ECC.A.8.2.4 or required by the **Bilateral Agreement** shall contain:

- (i) the **Voltage Control System** model including the **Power System Stabiliser** with settings as required under the **Planning Code** (PC.A.5.4) and **Bilateral Agreement**.
- (ii) on load time series dynamic simulation studies of the response of the **Voltage Control System** with and without the **Power System Stabiliser** to 2% and 10% steps in the reference voltage and a three phase short circuit fault applied to the **Grid Entry Point** or the **Interface Point** in the case of **OTSDUW Plant** and **Apparatus** for 100ms. The simulation studies should be carried out operating at full **Active Power** and maximum leading **Reactive Power** import condition with the fault level at the **Supergrid** HV connection point at minimum or as otherwise agreed with **NGET**. The results should show appropriate signals to demonstrate the expected damping performance of the **Power System Stabiliser**.
- (iii) any other simulation as specified in the **Bilateral Agreement** or agreed between the **Generator** or **HVDC System Owner** or **Offshore Transmission Licensee** and **NGET**.

ECP.A.3.3 Reactive Capability across the Voltage Range

ECP.A.3.3.1 (a) The ~~Generator or HVDC System Owner~~ shall supply simulation studies to demonstrate the capability to meet ECC.6.3.4.1 by submission of a report containing:

- (i) a load flow simulation study result to demonstrate the maximum lagging **Reactive Power** capability of the **Synchronous Power Generating Module**, ~~HVDC Equipment~~, **OTSUA** or **Power Park Module** at **Maximum Capacity** when the **Grid Entry Point** or **User System Entry Point** if **Embedded** or **Interface Point** (in the case of **OTSUA**) voltage is at 105% of nominal.
- (ii) a load flow simulation study result to demonstrate the maximum leading **Reactive Power** capability of the **Synchronous Power Generating Module**, **HVDC Equipment**, ~~OTSUA~~ or **Power Park Module** at **Maximum Capacity** when the **Grid Entry Point** or **User System Entry Point** if **Embedded** or **Interface Point** (in the case of **OTSUA**) voltage ~~if Embedded~~ is at 95% of nominal.
- (iii) a load flow simulation study result to demonstrate the maximum lagging **Reactive Power** capability of the **Synchronous Power Generating Module**, ~~HVDC Equipment~~ **OTSUA** or **Power Park Module** at the **Minimum Regulating Level** when the **Grid Entry Point** or **User System Entry Point** if **Embedded** or **Interface Point** (in the case of **OTSUA**) voltage is at 105% of nominal.

Formatted: Font: Bold

- (iv) a load flow simulation study result to demonstrate the maximum leading **Reactive Power** capability of the **Synchronous Power Generating Module, OTSUA HVDC Equipment** or **Power Park Module** at the **Minimum Regulating Level** when the **Grid Entry Point** or **User System Entry Point** voltage if **Embedded** or **Interface Point** (in the case of **OTSUA**) voltage is at 95% of nominal.

ECP.A.3.3.1 (b) The HVDC System Owner shall supply simulation studies to demonstrate the capability to meet ECC.6.3.4.1 by submission of a report containing:

- (i) a load flow simulation study result to demonstrate the maximum lagging **Reactive Power** capability of the **Synchronous Power Generating Module, HVDC Equipment, OTSUA** or **Power Park Module** at **Maximum HVDC Active Power Transmission Capacity** when the **Grid Entry Point** or **User System Entry Point** if **Embedded** or **Interface Point** (in case of **OTSUA**) voltage is at 105% of nominal.
- (ii) a load flow simulation study result to demonstrate the maximum leading **Reactive Power** capability of the **Synchronous Power Generating Module, HVDC Equipment, OTSUA** or **Power Park Module** at **Maximum HVDC Active Power Transmission Capacity** when the **Grid Entry Point** or **User System Entry Point** if **Embedded** or **Interface Point** (in case of **OTSUA**) voltage is at 95% of nominal.
- (iii) a load flow simulation study result to demonstrate the maximum lagging **Reactive Power** capability of the **Synchronous Power Generating Module, HVDC Equipment** or **Power Park Module** at the **Minimum HVDC Active Power Transmission Capacity** when the **Grid Entry Point** or **User System Entry Point** if **Embedded** or **Interface Point** (in case of **OTSUA**) voltage is at 105% of nominal.
- (iv) a load flow simulation study result to demonstrate the maximum leading **Reactive Power** capability of the **Synchronous Power Generating Module, HVDC Equipment** or **Power Park Module** at the **Minimum HVDC Active Power Transmission Capacity** when the **Grid Entry Point** or **User System Entry Point** voltage if **Embedded** or **Interface Point** (in case of **OTSUA**) is at 95% of nominal.

ECP.A.3.3.2 In the case of a **Synchronous- Power Generating Module** the terminal voltage in the simulation should be the nominal voltage for the machine.

ECP.A.3.3.3 In the case of a **Power Park Module** where the load flow simulation studies show that the individual **Power Park Units** deviate from nominal voltage to meet the **Reactive Power** requirements then evidence must be provided from factory (e.g. in a **Manufacturer's**

Data & Performance Report) or site testing that the **Power Park Unit** is capable of operating continuously at the operating points determined in the load flow simulation studies.

ECP.A.3.4 Voltage Control and Reactive Power Stability

ECP.A.3.4.1 This section applies to **HVDC Equipment**; and **Type C & Type D Power Park Modules** to demonstrate the voltage control capability and **Type B Power Park Modules** to demonstrate the voltage control capability if specified by **NGET**.

In the case of a power station containing **Power Park Modules** and/or **OTSUA** the **Generator** shall provide a report to demonstrate the dynamic capability and control stability of the **Power Park Module**. The report shall contain:

- (i) a dynamic time series simulation study result of a sufficiently large negative step in **System** voltage to cause a change in **Reactive Power** from zero to the maximum lagging value at **Rated MW**.
- (ii) a dynamic time series simulation study result of a sufficiently large positive step in **System** voltage to cause a change in **Reactive Power** from zero to the maximum leading value at **Rated MW**.
- (iii) a dynamic time series simulation study result to demonstrate control stability at the lagging **Reactive Power** limit by application of a -2% voltage step while operating within 5% of the lagging **Reactive Power** limit.
- (iv) a dynamic time series simulation study result to demonstrate control stability at the leading **Reactive Power** limit by application of a +2% voltage step while operating within 5% of the leading **Reactive Power** limit.

ECP.A.3.4.2 All the above studies should be completed with a ~~nominal~~ network operating at the voltage applicable for zero **Reactive Power** transfer at the **Grid Entry Point** or **User System Entry Point** if **Embedded** or, in the case of **OTSUA**, **Interface Point** unless stated otherwise. The and the fault level at the HV connection point should be set at the minimum level as agreed with **NGET**.

ECP.A.3.5 Fault Ride Through and Fast Fault Current Injection

ECP.A.3.5.1 This section applies to **Type B, Type C and Type D Power Generating Modules** and **HVDC Equipment** to demonstrate the modules fault ride through and **Fast Fault Current** injection capability.

The **Generator** or **HVDC System Owner** shall supply time series simulation study results to demonstrate the capability of **Synchronous Power Generating Module, HVDC Equipments, and Power Park Modules** and **OTSUA** to meet ECC.6.3.15 and ECC.6.3.16 by submission of a report containing:

- (i) a time series simulation study of a 140ms three phase short circuit fault with a retained voltage as detailed in table A.3.5.1 below applied at the **Grid Entry Point** or (**User System Entry Point if Embedded**) of the **Power Generating Module** or **HVDC Equipment** or **OTSUA**.
- (ii) a time series simulation study of 140ms unbalanced short circuit faults with a retained voltage as detailed in table [A.3.5.4-1](#) on the faulted phase(s) applied at the **Grid Entry Point** or (**User System Entry Point if Embedded**) of the **Power Generating Module** or **HVDC Equipment** or **OTSUA**. The unbalanced faults to be simulated are:
1. a phase to phase fault
 2. a two phase to earth fault
 3. a single phase to earth fault.

Power Generating Module	Retained Voltage
Synchronous Power Generating Module	
Type B	30%
Type C or Type D with Grid connection point voltage <110kV	10%
Type D with connection point voltage >110kV	0%
Power Park Module	
Type B or Type C or Type D with connection point voltage < 110kV	10%
Type D with connection point voltage >110kV	0%
HVDC Equipment	10%

Table A.3.5.1

For a **Power Generating Module** or **HVDC Equipment** or **OTSUA** the simulation study should be completed with the **Power Generating Module** or **HVDC Equipment** or **OTSUA** operating at full **Active Power** and maximum leading **Reactive Power** and the fault level at the **Supergrid** HV connection point at minimum or as otherwise agreed with **NGET** as detailed in ECC.6.3.15.8.

- (iii) time series simulation studies of balanced **Supergrid** voltage dips applied on the nearest point of the **National Electricity Transmission System** operating at **Supergrid** voltage to the **Synchronous Power Generating Module** or **OTSUA**. The simulation studies should include:
1. 50% retained voltage lasting 0.45 seconds
 2. 70% retained voltage lasting 0.81 seconds
 3. 80% retained voltage lasting 1.00 seconds
 4. 85% retained voltage lasting 180 seconds.

For a ~~Type C or Type D~~ **Synchronous Power Generating Module** or **OTSUA**, the simulation study should be completed with the **Synchronous Power Generating Module** or **OTSUA** operating at full **Active Power** and zero **Reactive Power** output and the fault level at

the **Supergrid** HV connection point at minimum or as otherwise agreed with **NGET**. Where the **Synchronous Power Generating Module** is **Embedded** the minimum **Network Operator's System** impedance to the **Supergrid** HV connection point shall be used which may be calculated from the maximum fault level at the **User System Entry Point**.

(iii) time series simulation studies of balanced **Supergrid** voltage dips applied on the nearest point of the **National Electricity Transmission System** operating at **Supergrid** voltage to the **HVDC Equipment** or **Power Park Module**. The simulation studies should include:

1. 30% retained voltage lasting 0.384 seconds
2. 50% retained voltage lasting 0.71 seconds
3. 80% retained voltage lasting 2.5 seconds
4. 85% retained voltage lasting 180 seconds.

For **HVDC Equipment** or **Power Park Modules** the simulation study should be completed with the **HVDC Equipment** or **Power Park Module** operating at full **Active Power** and zero **Reactive Power** output and the fault level at the **Supergrid** HV connection point at minimum or as otherwise agreed with **NGET**. Where the **HVDC Equipment** or **Power Park Module** is **Embedded** the minimum **Network Operator's System** impedance to the **Supergrid** HV connection point shall be used which may be calculated from the maximum fault level at the **User System Entry Point**.

For **HVDC Equipment** the simulations should include the duration of each voltage dip 1 to 4 above for which the **HVDC Equipment** will remain connected.

ECP.A.3.5.2 In the case of **Power Park Modules** comprised of **Power Park Units** in respect of which the **User's** reference to a **Manufacturer's Data & Performance Report** has been accepted by **NGET** for Fault Ride Through, ECP.A.3.5.1 will not apply provided:

(i) the **Generator** or **HVDC System Owner** demonstrates by load flow simulation study result that the faults and voltage dips at either side of the **Power Park Unit** transformer corresponding to the required faults and voltage dips in ECP.A.3.5.1 applied at the nearest point of the **National Electricity Transmission System** operating at **Supergrid** voltage are less than those included in the **Manufacturer's Data & Performance Report**,

or;

(ii) the same or greater percentage faults and voltage dips in ECP.A.3.5.1 have been applied at either side of the **Power Park Unit** transformer in the **Manufacturer's Data & Performance Report**.

ECP.A.3.6 **Limited Frequency Sensitive Mode – Over Frequency (LFSM-O)**

ECP.A.3.6.1 This section applies to **Type B, Type C and Type D Power Generating Modules, HVDC Equipment** to demonstrate the

capability to modulate Active Power at high frequency as required by ECC6.3.7.3.5(ii).

ECP.A.3.6.2 The simulation study should comprise of a **Power Generating Module** or **HVDC Equipment** connected to the total **System** with a local load shown as "X" in figure ECP.A.3.6.1. The load "X" is in addition to any auxiliary load of the **Power Station** connected directly to the **Power Generating Module** or **HVDC Equipment** and represents a small portion of the **System** to which the **Power Generating Module** or **HVDC Equipment** is attached. The value of "X" should be the minimum for which the **Power Generating Module** or **HVDC Equipment** can control the power island frequency to less than 52Hz consistent with ECC.6.3.7.3.5(ii). Where transient excursions above 52Hz occur the **Generator** or **HVDC Equipment Owner** should ensure that the duration above 52Hz is less than any high frequency protection system applied to the **Power Generating Module** or **HVDC Equipment**.

ECP.A.3.6.3 For HVDC Equipment and Power Park Modules consisting of units connected wholly by power electronic devices the simulation methodology may be modified by the addition of a **Synchronous Power Generating Module** (G2) connected as indicated in Figure ECP.A.3.6.2. This additional **Synchronous Power Generating Module** should have an inertia constant of 3.5MWs/MVA, be initially operating at rated power output and unity power factor. The mechanical power of the **Synchronous Power Generating Module** (G2) should remain constant throughout the simulation.

ECP.A.3.6.4 At the start of the simulation study the **Power Generating Module** or **HVDC Equipment** will be operating maximum **Active Power** output. The **Power Generating Module** or **HVDC Equipment** will then be islanded from the **Total System** but still supplying load "X" by the opening of a breaker, which is not the **Power Generating Module** or **HVDC Equipment** connection circuit breaker (the governor should therefore, not receive any signals that the breaker has opened other than the reduction in load and subsequent increase in speed). A schematic arrangement of the simulation study is illustrated by Figure ECP.A.3.6.1.

Formatted: Font: Bold

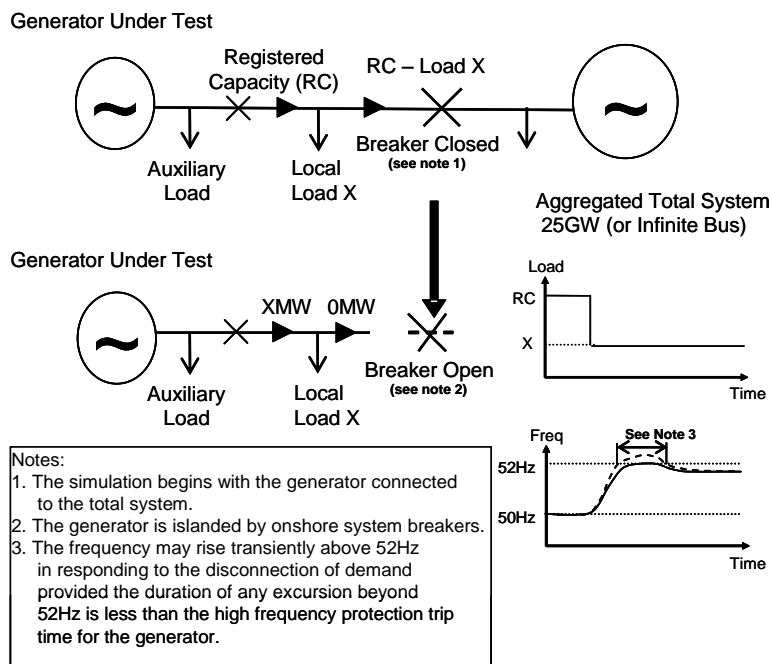

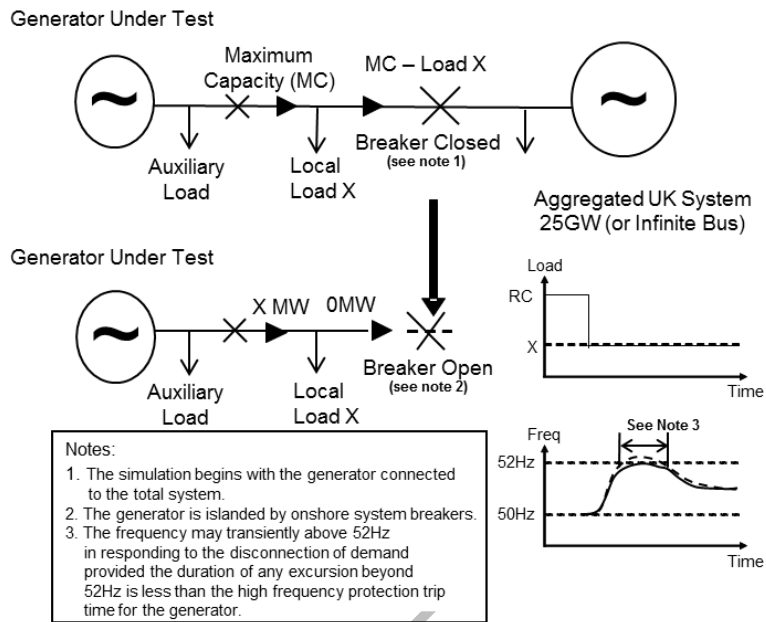

Figure ECP.A.3.6.1 – Diagram of Load Rejection Study

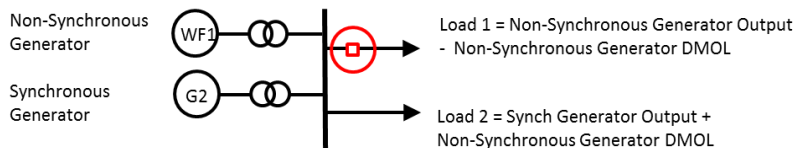

Figure ECP.A.3.6.2 – Addition of Generator G2 if applicable

ECP.A.3.6.5 Simulation study shall be performed for type B, C & D in **Limited Frequency Sensitive Mode (LFSM)** and **Frequency Sensitive Mode (FSM)** for type C & D. The simulation study results should indicate **Active Power** and **Frequency**.

ECP.A.3.6.6 To allow validation of the model used to simulate load rejection in accordance with ECC.6.3.7.3.5 as described a further simulation study is required to represent the largest positive **Frequency** injection step or fast ramp (BC1 and BC3 of Figure 2) that will be applied as a test as described in ECP.A.5.8 and ECP.A.6.6.

Limited Frequency Sensitive Mode – Under Frequency (LFSM-U)

ECP.A.3.6.7 This section applies to:
Synchronous Power Generating Modules, Type C & D; or,
HVDC Equipment; or,
Power Park Modules, Type C & D to demonstrate the modules capability to modulate Active Power at low frequency.

ECP.A.3.6.8 To demonstrate the LFSM-U low **Frequency** control when operating in **Limited Frequency Sensitive Mode** the **Generator** or **HVDC System Owner** shall submit a simulation study representing the response of the **Power Generating Module** or **HVDC Equipment** operating at 80% of **Maximum Capacity**. The simulation study event shall be equivalent to:

- (i) a sufficiently large reduction in the measured **System Frequency** ramped over 10 seconds to cause an increase in Active Power output to the **Maximum Capacity** followed by
- (ii) 60 seconds of steady state with the measured **System Frequency** depressed to the same level as in ECP.A.3.6.8.1 (i) as illustrated in Figure ECP.A.3.6.1 below.
- (iii) then increase of the measured **System Frequency** ramped over 10 seconds to cause a reduction in Active Power output back to the original Active Power level followed by at least 60 seconds of steady output.

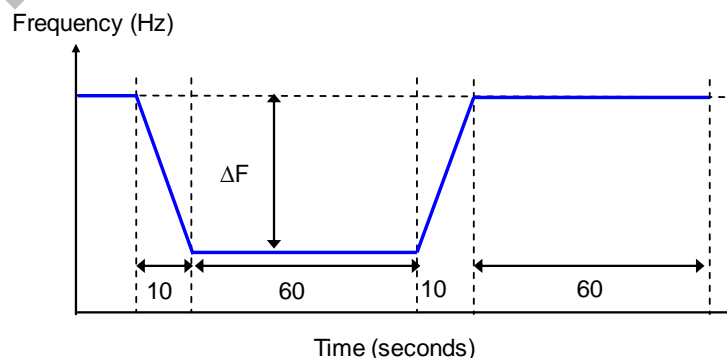

Figure ECP.A.3.6.1

ECP.A.3.7 Voltage and Frequency Controller Model Verification and Validation

ECP.A.3.7.1 For **Type C** and **Type D Synchronous Power Generating Modules, HVDC Equipment or Power Park Modules** the **Generator or HVDC System Owner** shall provide simulation studies to verify that the proposed controller models supplied to **NGET** under the **Planning Code** are fit for purpose. These simulation study results shall be provided in the timescales stated in the **Planning Code**.

ECP.A.3.7.2 To demonstrate the **Frequency** control or governor/load controller/plant model the **Generator or HVDC System Owner** shall submit a simulation study representing the response of the **Synchronous Power Generating Module, HVDC Equipment or Power Park Module** operating at 80% of **Maximum Capacity**. The simulation study event shall be equivalent to:

- (i) a ramped reduction in the measured **System Frequency** of 0.5Hz in 10 seconds followed by
- (ii) 20 seconds of steady state with the measured **System Frequency** depressed by 0.5Hz followed by
- (iii) a ramped increase in measured **System Frequency** of 0.3Hz over 30 seconds followed by
- (iv) 60 seconds of steady state with the measured **System Frequency** depressed by 0.2Hz as illustrated in Figure ECP.A.3.7.2 below.

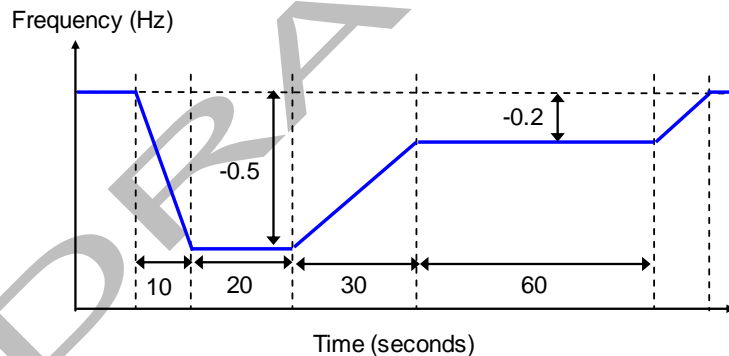

Figure ECP.A.3.7.2

The simulation study shall show **Active Power** output (MW) and the equivalent of **Frequency** injected.

ECP.A.3.7.3 To demonstrate the **Excitation System** model the **Generator** shall submit simulation studies representing the response of the **Synchronous Power Generating Module** as follows:

- (i) operating open circuit at rated terminal voltage and subjected to a 10% step increase in terminal voltage reference from 90% to 100%.
- (ii) operating at **Rated MW**, nominal terminal voltage and unity power factor subjected to a 2% step increase in the voltage reference. Where a **Power System Stabiliser** is included within the **Excitation System** this shall be in service.

The simulation study shall show the **Synchronous Power Generating Module** terminal voltage, field voltage, **Active Power**, **Reactive Power** and **Power System Stabiliser** output signal as appropriate.

- ECP.A.3.7.4 To demonstrate the Voltage Controller model the **Generator** or **HVDC System Owner** shall submit a simulation study representing the response of the **HVDC Equipment** or **Power Park Module** operating at **Rated MW** and unity power factor at the connection point to a 2% step increase in the voltage reference. The simulation study shall show the terminal voltage, **Active Power**, **Reactive Power** and **Power System Stabiliser** output signal as appropriate.
- ECP.A.3.7.5 To validate that the excitation and voltage control models submitted under the **Planning Code** are a reasonable representation of the dynamic behaviour of the **Synchronous Power Generating Module**, **HVDC Equipment** or **Power Park Module** as built, the **Generator** or **HVDC System Owner** shall repeat the simulation studies outlined above but using the operating conditions of the equivalent tests. The simulation study results shall be displayed overlaid on the actual test results.
- ECP.A.3.7.6 For **Type C** and **Type D Synchronous Power Generating Modules** or **HVDC Equipment** to validate that the governor/load controller/plant or **Frequency** control models submitted under the **Planning Code** is a reasonable representation of the dynamic behaviour of the **Synchronous Power Generating Module** or **HVDC Equipment Station** as built, the **Generator** or **HVDC System Owner** shall repeat the simulation studies outlined above but using the operating conditions of the equivalent tests. The simulation study results shall be displayed overlaid on the actual test results.
- ECP.A.3.8 Sub-synchronous Resonance control and Power Oscillation Damping control for **HVDC EquipmentSystem**.
- ECP.A.3.8.1 To demonstrate the compliance of the sub-synchronous control function_capability with ECC.6.3.17.1) and the terms of the **Bilateral Agreement** the **HVDC System Owner** shall submit a simulation study report
- ECP.A.3.8.2 Where power oscillation damping control function is specified on a **HVDC Equipment** the **HVDC System Owner** shall submit a simulation study report to demonstrate the compliance with ECC.6.3.17.2 and the terms of the **Bilateral Agreement**.
- ECP.A.3.8.3 The simulation studies should utilise the **HVDC Equipment** control system models including the settings as required under the **Planning Code** (PC.A.5.3.2). The network conditions for the above simulation studies should be discussed with **NGET** prior to commencing any simulation studies.

APPENDIX 4

ONSITE SIGNAL PROVISION FOR WITNESSING TESTS

Formatted: Font: Not Bold

ECP.A.4.1 During any tests witnessed on-site by **NGET**, the following signals shall be provided to **NGET** by the **Generator** undertaking **OTSDUW or HVDC System Owner** in accordance with ECC.6.6.3.

ECP.A.4.2 **Synchronous Power Generating Modules**

ECP.A.4.2(a) All Tests	<ul style="list-style-type: none"> • MW - Active Power at Synchronous Generating Unit terminals
ECP.A.4.2(b) Reactive & Excitation System	<ul style="list-style-type: none"> • MVar - Reactive Power at terminals • Vt - Synchronous Generating Unit terminal voltage • Efd- Synchronous Generating Unit field voltage and/or main exciter field voltage • Ifd – Synchronous Generating Unit Field current (where possible) • Power System Stabiliser output, where applicable. • Noise – Injected noise signal (where applicable and possible)
ECP.A.4.2(c) Governor System & Frequency Response	<ul style="list-style-type: none"> • Fsys - System Frequency • Finj - Injected Speed Setpoint • Logic - Stop / Start Logic Signal <p>For Gas Turbines:</p> <ul style="list-style-type: none"> • GT Fuel Demand • GT Fuel Valve Position • GT Inlet Guide Vane Position • GT Exhaust Gas Temperature <p>For Steam Turbines at ≥ 1Hz:</p> <ul style="list-style-type: none"> • Pressure before Turbine Governor Valves • Turbine Governor Valve Positions • Governor Oil Pressure* • Boiler Pressure Set Point * • Superheater Outlet Pressure * • Pressure after Turbine Governor Valves* • Boiler Firing Demand* <p>*Where applicable (typically not in CCGT module)</p> <p>For Hydro Plant:</p> <ul style="list-style-type: none"> • Speed Governor Demand Signal • Actuator Output Signal • Guide Vane / Needle Valve Position
ECP.A.4.2(d) Compliance with ECC.6.3.3	<ul style="list-style-type: none"> • Fsys - System Frequency • Finj - Injected Speed Setpoint • Appropriate control system parameters as agreed with NGET (See ECP.A.5.9)
ECP.A.4.2(e) Real Time on site	<ul style="list-style-type: none"> • MW - Synchronous Power Generating Module Active Power at the Grid Entry

or Down-loadable	<p>Point or (User System Entry Point if Embedded).</p> <ul style="list-style-type: none"> • MVA_r - Synchronous Power Generating Module Reactive Power at the Grid Entry Point or (User System Entry Point if Embedded). • Line-line Voltage (kV) at the Grid Entry Point or (User System Entry Point if Embedded).
------------------	---

Formatted: Font: Not Bold

Formatted: Font: Not Bold

ECP.A.4.3 Power Park Modules, OTSDUA and HVDC Equipment

	Each Power Park Module and HVDC Equipment at Grid Entry Point or User System Entry Point
ECP.A.4.3.1(a) Real Time on site.	<ul style="list-style-type: none"> • Total Active Power (MW) • Total Reactive Power (MVA_r) • Line-line Voltage (kV) • System Frequency (Hz)
ECP.A.4.3.1(b) Real Time on site or Down-loadable	<ul style="list-style-type: none"> • Injected frequency signal (Hz) or test logic signal (Boolean) when appropriate • Injected voltage signal (per unit voltage) or test logic signal (Boolean) when appropriate • In the case of an Onshore Power Park Module the Onshore Power Park Module site voltage (MV) (kV) • Power System Stabiliser output, where appropriate • In the case of a Power Park Module or HVDC Equipment where the Reactive Power is provided by from more than one Reactive Power source, the individual Reactive Power contributions from each source, as agreed with NGET. • In the case of HVDC Equipment appropriate control system parameters as agreed with NGET (See ECP.A.7) • In the case of an Offshore Power Park Module the Total Active Power (MW) and the Total Reactive Power (MVA_r) at the offshore Grid Entry Point
ECP.A.4.3.1(c) Real Time on site or Down-loadable	<ul style="list-style-type: none"> • Available power for Power Park Module (MW) • Power source speed for Power Park Module (e.g. wind speed) (m/s) when appropriate • Power source direction for Power Park Module (degrees) when appropriate <p>See ECP.A.4.3.2</p>

ECP.A.4.3.2 **NGET** accept that the signals specified in ECP.A.4.3.1(c) may have lower effective sample rates than those required in ECC.6.6.3 although any signals supplied for connection to **NGET's** recording equipment which do not meet at least the sample rates detailed in

ECC.6.6.3 should have the actual sample rates indicated to **NGET** before testing commences.

- ECP.A.4.3.3 For all **NGET** witnessed testing either;
- (i) the **Generator** or **HVDC System Owner** shall provide to **NGET** all signals outlined in ECP.A.4.3.1 direct from the **Power Park Module** control system without any attenuation, delay or filtering which would result in the inability to fully demonstrate the objectives of the test, or identify any potential safety or plant instability issues, and with a signal update rate corresponding to ECC.6.6.3.2; or
 - (ii) in the case of **Onshore Power Park Modules** the **Generator HVDC System Owner** shall provide signals ECP.A.4.3.1–(a) direct from one or more transducer(s) connected to current and voltage transformers for monitoring in real time on site; or,
 - (iii) In the case of **Offshore Power Park Modules** and **OTSDUA** signals ECP.A.4.3.1(a) will be provided at the **Interface Point** by the **Offshore Transmission Licensee** pursuant to the STC or by the **Generator** when **OTSDUW Arrangements** apply.

ECP.A.4.3.4 Options ECP.A.4.3.3 (ii) and (iii) will only be available on condition that;

- (a) all signals outlined in ECP.A.4.3.1 are recorded and made available to **NGET** by the **Generator** or **HVDC System Owner** from the **Power Park Module** or **OTSDUA** or **HVDC Equipment** control systems as a download once the testing has been completed; and
- (b) the full test results are provided by the **Generator HVDC System Owner** within 2 working days of the test date to **NGET** unless **NGET** agrees otherwise; and
- (c) all data is provided with a sample rate in accordance with ECC.6.6.3.3 unless **NGET** agrees otherwise; and
- (d) in **NGET's** reasonable opinion the solution does not unreasonably add a significant delay between tests or impede the volume of testing which can take place on the day.

ECP.A.4.3.5 In the case of where transducers connected to current and voltage transformers are installed (ECP.A.4. 3.3–(ii) and (iii)), the transducers shall meet the following specification

- (a) The transducer(s) shall be permanently installed to easily allow safe testing at any point in the future, and to avoid a requirement for recalibration of the current transformers and voltage transformers.
- (b) The transducer(s) should be directly connected to the metering quality current transformers and voltage transformers or similar.

- (c) The transducers shall either have a response time no greater than 50ms to reach 90% of output, or no greater than 300ms to reach 99.5%.

DRAFT

APPENDIX 5

COMPLIANCE TESTING OF SYNCHRONOUS POWER GENERATING MODULES

ECP.A.5.1 SCOPE

Formatted: Underline

ECP.A.5.1.1 This Appendix sets out the tests contained therein to demonstrate compliance with the relevant clauses of the European Connection Conditions of the **Grid Code**. This Appendix shall be read in conjunction with the ECP with regard to the submission of the reports to **NGET**.

ECP.A.5.1.2 The tests specified in this Appendix will normally be sufficient to demonstrate compliance however **NGET** may:

- (i) agree an alternative set of tests provided **NGET** deem the alternative set of tests sufficient to demonstrate compliance with the **Grid Code** and **Bilateral Agreement**; and/or
- (ii) require additional or alternative tests if information supplied to **NGET** during the compliance process suggests that the tests in this Appendix will not fully demonstrate compliance with the relevant section of the **Grid Code** or **Bilateral Agreement**.
- (iii) Agree a reduced set of tests for subsequent **Synchronous Power Generating Module** following successful completion of the first **Synchronous Power Generating Module** tests in the case of a **Power Station** comprised of two or more **Synchronous Power Generating Module** which **NGET** reasonably considers to be identical.

If:

- (a) the tests performed pursuant to ECP.A.5.1.2(iii) in respect of subsequent **Synchronous Power Generating Modules** do not replicate the full tests for the first **Synchronous Power Generating Module** , or
- (b) any of the tests performed pursuant to ECP.A.5.1.2(iii) do not fully demonstrate compliance with the relevant aspects of the **Grid Code, Ancillary Services Agreement** and / or **Bilateral Agreement**,

then notwithstanding the provisions above, the full testing requirements set out in this Appendix will be applied.

ECP.A.5.1.3 The **Generator** is responsible for carrying out the tests set out in and in accordance with this Appendix and the **Generator** retains the responsibility for the safety of personnel and plant during the test. **NGET** will witness all of the tests outlined or agreed in relation to this Appendix unless **NGET** decides and notifies the **Generator** otherwise. Reactive Capability tests may be witnessed by **NGET** remotely from the **NGET** control centre. For all on site **NGET** witnessed tests the **Generator** should ensure suitable representatives from the **Generator** and manufacturer (if appropriate) are available on site for the entire

testing period. In all cases the **Generator** shall provide suitable monitoring equipment to record all relevant test signals as outlined below in ECP.A.6.1.5.

ECP.A.5.1.6 The **Generator** shall submit a schedule of tests to **NGET** in accordance with CP.4.3.1.

ECP.A.5.1.7 Prior to the testing of a **Synchronous Power Generating Module** the **Generator** shall complete the **Integral Equipment Test** procedure in accordance with OC.7.5.

ECP.A.5.1.8 Full **Synchronous Power Generating Module** testing as required by CP.7.2 is to be completed as defined in ECP.A.5.2 through to ECP.A.5.9.

ECP.A.5.1.9 **NGET** will permit relaxation from the requirement ECP.A.5.2 to ECP.A.5.9 where an **Equipment Certificate** for the **Synchronous Power Generating Module** has been provided which details the characteristics from tests on a representative machine with the same equipment and settings and the performance of the **Synchronous Power Generating Module** can, in **NGET's** opinion, reasonably represent that of the installed **Synchronous Power Generating Module** at that site. For **Type B, Type C** and **Type D Power Generating Modules** the relevant **Equipment Certificate** must be supplied in the **Power Generating Module Document** or **Users Data File structure** as applicable.

ECP.A.5.2 Excitation System Open Circuit Step Response Tests

ECP.A.5.2.1 The open circuit step response of the **Excitation System** will be tested by applying a voltage step change from 90% to 100% of the nominal **Synchronous Power Generating Module** terminal voltage, with the **Synchronous Power Generating Module** on open circuit and at rated speed.

ECP.A.5.2.1 The test shall be carried out prior to synchronisation in accordance with CP.6.4. This is not witnessed by **NGET** unless specifically requested by **NGET**. Where **NGET** is not witnessing the tests, the Generator shall supply the recordings of the following signals to **NGET** in an electronic spreadsheet format:

V_t - **Synchronous Generating Unit** terminal voltage
E_{fd} - **Synchronous Generating Unit** field voltage or main exciter field voltage
I_{fd} - **Synchronous Generating Unit** field current (where possible)
Step injection signal

ECP.A.5.2.3 Results shall be legible, identifiable by labelling, and shall have appropriate scaling.

ECP.A.5.3 Open & Short Circuit Saturation Characteristics

ECP.A.5.3.1 The test shall normally be carried out prior to synchronisation in accordance with ECP.6.2.4, or ECP.6.3.4. **Equipment Certificates** or Manufacturer's Test Certificates may be used where appropriate may

Formatted: Font: Bold

be used if agreed by NGET.

ECP.A.5.3.2 This is not witnessed by **NGET**. Graphical and tabular representations of the results in an electronic spreadsheet format showing per unit open circuit terminal voltage and short circuit current versus per unit field current shall be submitted to **NGET**.

ECP.A.5.3.3 Results shall be legible, identifiable by labelling, and shall have appropriate scaling.

ECP.A.5.4 **Excitation System On-Load Tests**

ECP.A.5.4.1 The time domain performance of the **Excitation System** shall be tested by application of voltage step changes corresponding to 1% and 2% of the nominal terminal voltage.

ECP.A.5.4.2 Where a **Power System Stabiliser** is present:

- (i) The **PSS** must only be commissioned in accordance with BC2.11.2. When a **PSS** is switched on for the first time as part of on-load commissioning or if parameters have been adjusted the **Generator** should consider reducing the **PSS** output gain by at least 50% and should consider reducing the limits on **PSS** output by at least a factor of 5 to prevent unexpected **PSS** action affecting the stability of the **Synchronous Generating Unit** or the **National Electricity Transmission System**.
- (ii) The time domain performance of the **Excitation System** shall be tested by application of voltage step changes corresponding to 1% and 2% of the nominal terminal voltage, repeating with and without the **PSS** in service.
- (iii) The frequency domain tuning of the **PSS** shall also be demonstrated by injecting a 0.2Hz-3Hz band limited random noise signal into the **Automatic Voltage Regulator** Setpoint with the **Synchronous Generating Unit** operating at points specified by **NGET** (up to rated MVA output).
- (iv) The **PSS** gain margin shall be tested by increasing the **PSS** gain gradually to threefold and observing the **Synchronous Generating Unit** steady state **Active Power** output.
- (v) The interaction of the **PSS** with changes in **Active Power** shall be tested by application of a +0.5Hz frequency injection to the governor while the **Synchronous Generating Unit** is selected to **Frequency Sensitive Mode**.
- (vi) If the **Synchronous Power Generating Module** is of the **Pumped Storage** type then the step tests shall be carried out, with and without the **PSS**, in the pumping mode in addition to the generating mode.
- (vii) Where the **Bilateral Agreement** requires that the **PSS** is in service at a specified loading level additional testing witnessed by **NGET** will be required during the commissioning process

Formatted: Font: Bold

before the **Synchronous Power Generating Module** may exceed this output level.

- (viii) Where the **Excitation System** includes a **PSS**, the **Generator** shall provide a suitable noise source to facilitate noise injection testing.

ECP.A.5.4.3 The following typical procedure is provided to assist **Generators** in drawing up their own site specific procedures for the **NGET** witnessed **PSS** Tests.

Test	Injection	Notes
	Synchronous Generating Unit running at Maximum Capacity, unity pf, PSS Switched Off	
1	<ul style="list-style-type: none"> Record steady state for 10 seconds Inject +1% step to AVR Voltage Setpoint and hold for at least 10 seconds until stabilised Remove step returning AVR Voltage Setpoint to nominal and hold for at least 10 seconds 	
2	<ul style="list-style-type: none"> Record steady state for 10 seconds Inject +2% step to AVR Voltage Setpoint and hold for at least 10 seconds until stabilised Remove step returning AVR Voltage Setpoint to nominal and hold for at least 10 seconds 	
3	<ul style="list-style-type: none"> Inject band limited (0.2-3Hz) random noise signal into voltage Setpoint and measure frequency spectrum of Real Power. Remove noise injection. 	
	Switch On Power System Stabiliser	
4	<ul style="list-style-type: none"> Record steady state for 10 seconds Inject +1% step to AVR Voltage Setpoint and hold for at least 10 seconds until stabilised Remove step returning AVR Voltage Setpoint to nominal and hold for at least 10 seconds 	
5	<ul style="list-style-type: none"> Record steady state for 10 seconds Inject +2% step to AVR Voltage Setpoint and hold for at least 10 seconds until stabilised Remove step returning AVR Voltage Setpoint to nominal and hold for at least 10 seconds 	
6	<ul style="list-style-type: none"> Increase PSS gain at 30second intervals. i.e. x1 – x1.5 – x2 – x2.5 – x3 Return PSS gain to initial setting 	
7	<ul style="list-style-type: none"> Inject band limited (0.2-3Hz) random noise signal into voltage Setpoint and measure frequency spectrum of Real Power. Remove noise injection. 	
8	<ul style="list-style-type: none"> Select the governor to FSM Inject +0.5 Hz step into governor. Hold until generator MW output is stabilised Remove step 	

ECP.A.5.5 **Under-excitation Limiter Performance Test**

- ECP.A.5.5.1 Initially the performance of the **Under-excitation Limiter** should be checked by moving the limit line close to the operating point of the **Synchronous Generating Unit** when operating close to unity power factor. The operating point of the **Synchronous Generating Unit** is then stepped into the limit by applying a 2% decrease in **Automatic Voltage Regulator Setpoint** voltage.
- ECP.A.5.5.2 The final performance of the **Under-excitation Limiter** shall be demonstrated by testing its response to a step change corresponding to a 2% decrease in **Automatic Voltage Regulator Setpoint** voltage when the **Synchronous Generating Unit** is operating just off the limit line, at the designed setting as indicated on the **Performance Chart** [P-Q Capability Diagram] submitted to **NGET** under OC2.
- ECP.A.5.5.3 Where possible the **Under-excitation Limiter** should also be tested by operating the tap- changer when the **Synchronous Generating Unit** is operating just off the limit line, as set up.
- ECP.A.5.5.4 The **Under-excitation Limiter** will normally be tested at low active power output ~~(minimum stable operating level)~~ and at maximum **Active Power** output ~~(Maximum Capacity)~~.
- ECP.A.5.5.5 The following typical procedure is provided to assist **Generators** in drawing up their own site specific procedures for the **NGET** witnessed **Under-excitation Limiter** Tests.

Test	Injection	Notes
	Synchronous Generating Unit running at Maximum Capacity and unity power factor. Under-excitation limit temporarily moved close to the operating point of the Synchronous Generating Unit .	
1	<ul style="list-style-type: none"> • PSS on. • Inject -2% voltage step into AVR voltage Setpoint and hold at least for 10 seconds until stabilised • Remove step returning AVR Voltage Setpoint to nominal and hold for at least 10 seconds 	
	Under-excitation limit moved to normal position. Synchronous Generating Unit running at Maximum Capacity and at leading Reactive Power close to Under-excitation limit.	
2	<ul style="list-style-type: none"> • PSS on. • Inject -2% voltage step into AVR voltage Setpoint and hold at least for 10 seconds until stabilised • Remove step returning AVR Voltage Setpoint to nominal and hold for at least 10 seconds 	

ECP.A.5.6 Over-excitation Limiter Performance Test

- ECP.A.5.6.1 The performance of the **Over-excitation Limiter**, where it exists, shall be demonstrated by testing its response to a step increase in the Automatic Voltage Regulator Setpoint voltage that results in operation of the **Over-excitation Limiter**. Prior to application of the step the **Synchronous Generating Unit** shall be generating **Maximum Capacity** and operating within its continuous **Reactive Power** capability. The size of the step will be determined by the minimum

value necessary to operate the **Over-excitation Limiter** and will be agreed by **NGET** and the **Generator**. The resulting operation beyond the **Over-excitation Limit** shall be controlled by the **Over-excitation Limiter** without the operation of any protection that could trip the **Synchronous Power Generating Module**. The step shall be removed immediately on completion of the test.

ECP.A.5.6.2 If the **Over-excitation Limiter** has multiple levels to account for heating effects, an explanation of this functionality will be necessary and if appropriate, a description of how this can be tested.

ECP.A.5.6.3 The following typical procedure is provided to assist **Generators** in drawing up their own site specific procedures for the **NGET** witnessed **Under-excitation Limiter** Tests.

Test	Injection	Notes
	Synchronous Generating Unit running at Maximum Capacity and maximum lagging Reactive Power .	
	Over-excitation Limit temporarily set close to this operating point. PSS on.	
1	<ul style="list-style-type: none"> • Inject positive voltage step into AVR voltage Setpoint and hold • Wait till Over-excitation Limiter operates after sufficient time delay to bring back the excitation back to the limit. • Remove step returning AVR Voltage Setpoint to nominal. 	
	Over-excitation Limit restored to its normal operating value. PSS on.	

ECP.A.5.7 Reactive Capability

ECP.A.5.7.1 The **Reactive Power** capability on each **Synchronous Power Generating Module** will normally be demonstrated by :

- (a) operation of the **Synchronous Power Generating Module** at maximum lagging **Reactive Power** and Maximum Capacity for 1 hour
- (b) operation of the **Synchronous Power Generating Module** at maximum leading **Reactive Power** and Maximum Capacity for 1 hour.
- (c) operation of the **Synchronous Power Generating Module** at maximum lagging **Reactive Power** and ~~---~~ **Minimum Stable Operating Level** for 1 hour
- (d) operation of the **Synchronous Power Generating Module** at maximum leading **Reactive Power** and **Minimum Stable Operating Level** for 1 hour.
- (e) operation of the **Synchronous Power Generating Module** at maximum lagging **Reactive Power** and a power output between **Maximum Capacity** and **Minimum Stable Operating Level**.
- (f) operation of the **Synchronous Power Generating Module** at maximum leading **Reactive Power** and a power output between **Maximum Capacity** and **Minimum Stable Operating Level**.

ECP.A.5.7.2 In the case of an **Embedded Synchronous Power Generating Module** where distribution network considerations restrict the **Synchronous Power Generating Module Reactive Power Output** ~~then the maximum leading and lagging capability will be demonstrated without breaching the host network operators limits~~ **NGET will only require demonstration within the acceptable limits of the Network Operator's System.**

Formatted: Font: Bold

Formatted: Font: Bold

Formatted: Font: Bold

ECP.A.5.7.3 The test procedure, time and date will be agreed with **NGET** and will be to the instruction of **NGET** control centre and shall be monitored and recorded at both the **NGET** control centre and by the **Generator**.

Formatted: Font: Bold

ECP.A.5.7.4 Where the **Generator** is recording ~~the voltage and Reactive Power at the Synchronous Power Generating Module terminals and the~~ voltage, **Active Power** and **Reactive Power** at the HV connection point the voltage for these tests **Active Power and Reactive Power** at the **Synchronous Power Generating Module** terminals may also shall be included. The results shall be supplied in an electronic spreadsheet format. Where applicable the **Synchronous Power Generating Module** transformer tapchanger position should be noted throughout the test period.

Formatted: Not Highlight

Formatted: Font: Bold

Formatted: Not Highlight

Formatted: Font: Bold

ECP.A.5.8 Governor and Load Controller Response Performance

ECP.A.5.8.1 The governor and load controller response performance will be tested by injecting simulated frequency deviations into the governor and load controller systems. Such simulated frequency deviation signals must be injected simultaneously at both speed governor and load controller setpoints. For **CCGT modules**, simultaneous injection into all gas turbines, steam turbine governors and module controllers is required.

ECP.A.5.8.2 Prior to witnessing the governor tests set out in ECP.A.5.8.6, **NGET** requires the **Generator** to conduct the preliminary tests detailed in ECP.A.5.8.4 and send the results to **NGET** for assessment unless agreed otherwise by **NGET**. The results should be supplied in an electronic spreadsheet format. These tests shall be completed at least two weeks prior to the witnessed governor response tests.

ECP.A.5.8.3 Where a **CCGT module** or **Synchronous Power Generating Module** is capable of operating on alternative fuels, tests will be required to demonstrate performance when operating on each fuel. **NGET** may agree a reduction from the tests listed in ECP.A.5.8.6 for demonstrating performance on the alternative fuel. This includes the case where a main fuel is supplemented by bio-fuel.

Preliminary Governor Frequency Response Testing

ECP.A.5.8.4 Prior to conducting the full set of tests as per ECP.A.5.8.6, **Generators** are required to conduct a preliminary set of tests below to confirm the frequency injection method is correct and the plant control performance is within expectation. The test numbers refer to Figure 1 below. With the plant running at 80% of full load, the following frequency injections shall be applied.

Test No (Figure1)	Frequency Injection	Notes
8	<ul style="list-style-type: none"> Inject -0.5Hz frequency fall over 10 sec Hold for a further 20 sec At 30 sec from the start of the test, Inject a +0.3Hz frequency rise over 30 sec. Hold until conditions stabilise Remove the injected signal <u>as a ramp over 10 seconds</u> 	
13	<ul style="list-style-type: none"> Inject - 0.5Hz frequency fall over 10 sec Hold until conditions stabilise Remove the injected signal <u>as a ramp over 10 seconds</u> 	
14	<ul style="list-style-type: none"> Inject +0.5Hz frequency rise over 10 sec Hold until conditions stabilise Remove the injected signal <u>as a ramp over 10 seconds</u> 	
H	<ul style="list-style-type: none"> Inject - 0.5Hz frequency fall as a stepchange Hold until conditions stabilise Remove the injected signal <u>as a stepchange</u> 	
I	<ul style="list-style-type: none"> Inject +0.5Hz frequency rise as a stepchange Hold until conditions stabilise Remove the injected signal <u>as a stepchange</u> 	

ECP.A.5.8.5 The recorded results (e.g. Finj, MW and control signals) should be sampled at a minimum rate of 1 Hz to allow **NGET** to assess the plant performance from the initial transients (seconds) to the final steady state conditions (5-15 minutes depending on the plant design). This is not witnessed by **NGET**. The **Generator** shall supply the recordings including data to **NGET** in an electronic spreadsheet format. Results shall be legible, identifiable by labelling, and shall have appropriate scaling.

Full Frequency Response Testing Schedule Witnessed by **NGET**

ECP.A.5.8.6 The tests are to be conducted at a number of different Module Load Points (MLP). The load points are conducted as shown below unless agreed otherwise by **NGET**.

Module Load Point 6 (Maximum Export Limit)	100% MEL
Module Load Point 5	95% MEL
Module Load Point 4 (Mid-point of Operating Range)	80% MEL
Module Load Point 3	70% MEL
Module Load Point 2 (Lower of MRL+10% or Minimum Stable Operating Level)	MRL+10% or MSOL
Module Load Point 1 (Minimum regulating level)	MRL

Formatted: Font: Bold

ECP.A.5.8.7 The tests are divided into the following three types;

- (i) Frequency response compliance and volume tests as per ECP.A.5.8. Figure 1. These tests consist of frequency profile and ramp tests and adjustments to the target frequency setpoint as per ECP.5.8 Figure 3.-
- (ii) System islanding and step response tests as shown by ECP.A.5.8. Figure 2.

- (iii) Frequency response tests in **Limited Frequency Sensitive Mode (LFSM)** to demonstrate **LFSM-O** and **LFSM-U** capability as shown by ECP.A.5.8 Figure 2.

ECP.A.5.8.8 There should be sufficient time allowed between tests for control systems to reach steady state. Where the diagram states 'HOLD' the current injection should be maintained until the **Active Power (MW)** output of the **Synchronous Power Generating Module** or **CCGT Module** has stabilised. The frequency response capability test (see Figure 1) injection signal shall be returned to zero at the same rate at which it was applied. **NGET** may require repeat tests should the tests give unexpected results.

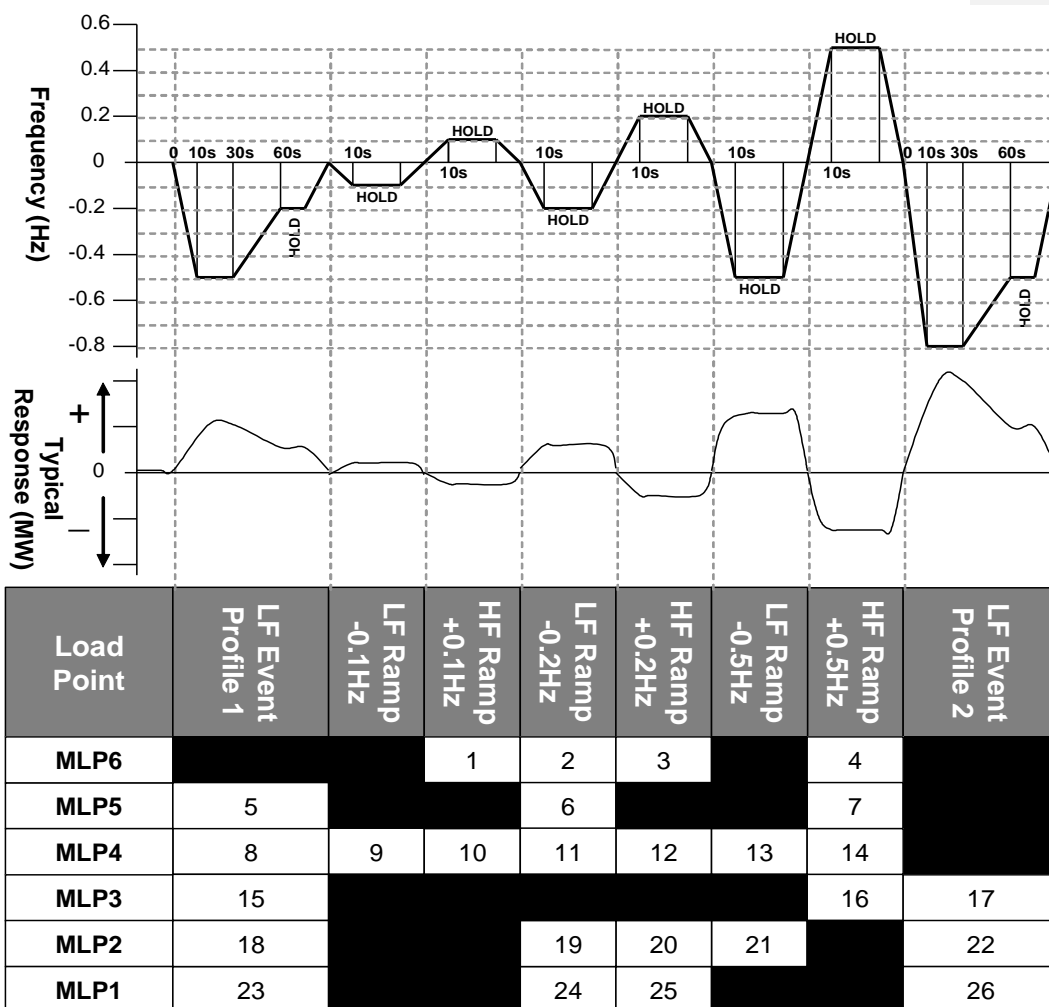

Figure 1: Frequency Response Capability FSM Ramp Response Tests

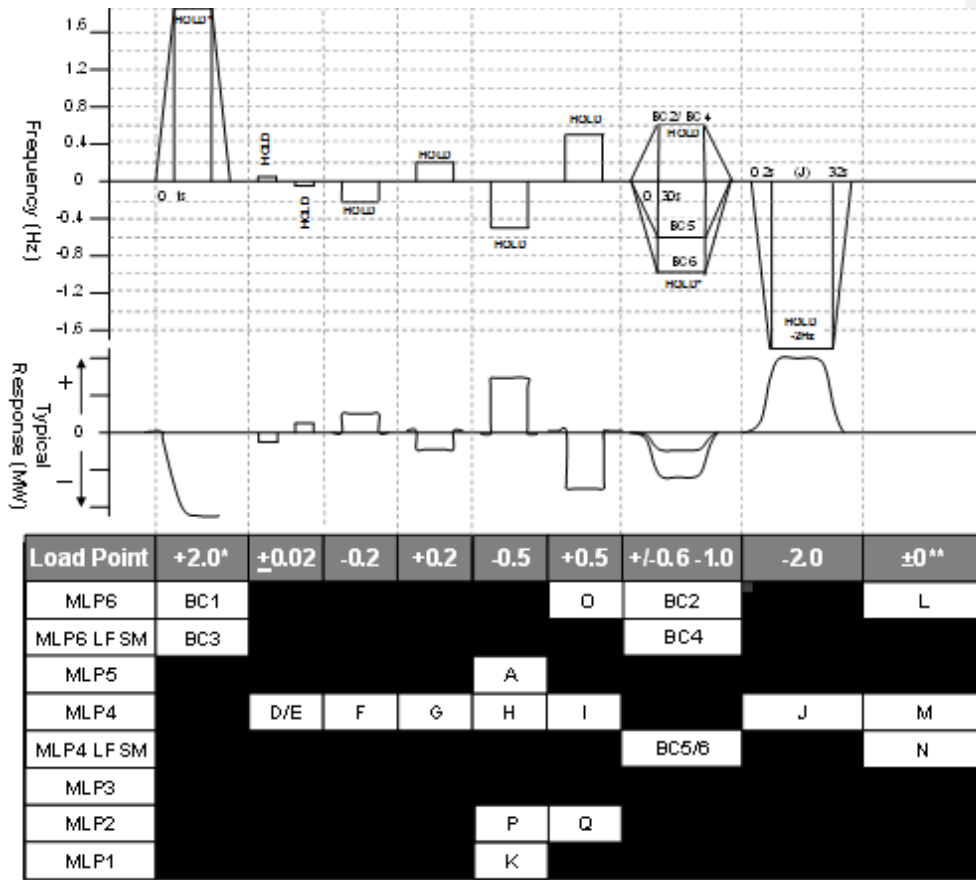

Figure 2: [Frequency Response Capability LFSM-O, LFSM-U and FSM Step Response Tests](#) [System islanding and step response tests](#)

* This will generally be +2.0Hz unless an injection of this size causes a reduction in plant output that takes the operating point below **Minimum Stable Operating Level** in which case an appropriate injection should be calculated in accordance with the following:
 For example 0.9Hz is needed to take an initial output 65% to a final output of 20%. If the initial output was not 65% and the **Minimum Stable Operating Level** is not 20% then the injected step should be adjusted accordingly as shown in the example given below

Initial Output 65%
Minimum Stable Operating Level 20%
 Frequency Controller Droop 4%
 Frequency to be injected = $(0.65-0.20) \times 0.04 \times 50 = 0.9\text{Hz}$

** Tests L and M in Figure 2 shall be conducted if in this range of tests the system frequency feedback signal is replaced by the injection signal rather than the injection signal being added to the system frequency signal. The tests will consist of monitoring the

Synchronous Power Generating Module and CCGT Module in Frequency Sensitive Mode during normal system frequency variations without applying any injection. Test N in figure 2 shall be conducted in all cases. All three tests should be conducted for a period of at least 10 minutes.

ECP.A.5.8.98 The target frequency adjustment facility should be demonstrated from the normal control point within the range of 49.9Hz to 50.1Hz by step changes to the target frequency setpoint as indicated in ECP.A.5.8 Figure 3-

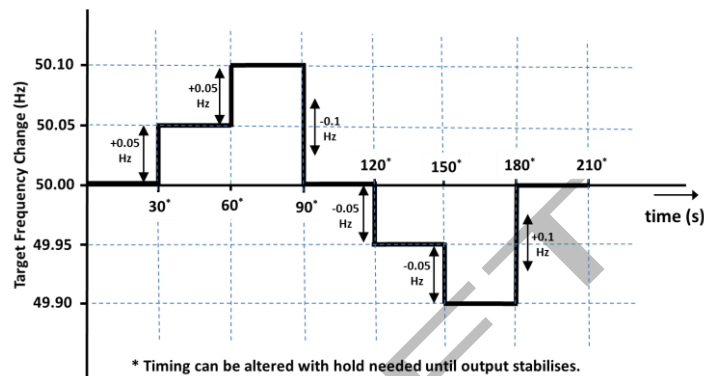

ECP.A.5.8 Figure 3 – Target Frequency setting changes

ECP.A.5.9 Compliance with ECC.6.3.3 Functionality Test

ECP.A.5.9.1 Where the plant design includes active control function or functions to deliver ECC.6.3.3 compliance, the **Generator** will propose and agree a test procedure with **NGET**, which will demonstrate how the **Synchronous Power Generating Module Active Power** output responds to changes in **System Frequency** and ambient conditions (e.g. by **Frequency** and temperature injection methods).

ECP.A.5.9.2 The **Generator** shall inform **NGET** if any load limiter control is additionally employed.

ECP.A.5.9.3 With Setpoint to the signals specified in ECP.A.4, **NGET** will agree with the **Generator** which additional control system parameters shall be monitored to demonstrate the functionality of ECC.6.3.3 compliance systems. Where **NGET** recording equipment is not used results shall be supplied to **NGET** in an electronic spreadsheet format

DRAFT

APPENDIX 6

COMPLIANCE TESTING OF POWER PARK MODULES

ECP.A.6.1 SCOPE

ECP.A.6.1.1 This Appendix outlines the general testing requirements for **Power Park Modules** and **OTSDUA** to demonstrate compliance with the relevant aspects of the **Grid Code, Ancillary Services Agreement** and **Bilateral Agreement**. The tests specified in this Appendix will normally be sufficient to demonstrate compliance however **NGET** may:

- i) agree an alternative set of tests provided **NGET** deem the alternative set of tests sufficient to demonstrate compliance with the **Grid Code, Ancillary Services Agreement** and **Bilateral Agreement**; and/or
- ii) require additional or alternative tests if information supplied to **NGET** during the compliance process suggests that the tests in this Appendix will not fully demonstrate compliance with the relevant section of the **Grid Code, Ancillary Services Agreement** or **Bilateral Agreement**; and/or
- iii) require additional tests if a **Power System Stabiliser** is fitted; and/or
- iv) agree a reduced set of tests if a relevant **Manufacturer's Data & Performance Report** has been submitted to and deemed to be appropriate by **NGET**; and/or
- v) agree a reduced set of tests for subsequent **Power Park Modules** or **OTSDUA** following successful completion of the first **Power Park Module** or **OTSDUA** tests in the case of a **Power Station** comprised of two or more **Power Park Modules** or **OTSDUA** which **NGET** reasonably considers to be identical.

If:

- (a) the tests performed pursuant to ECP.A.6.1.1(iv) do not replicate the results contained in the **Manufacturer's Data & Performance Report** or
- (b) the tests performed pursuant to ECP.A.6.1.1(v) in respect of subsequent **Power Park Modules** or **OTSDUA** do not replicate the full tests for the first **Power Park Module** or **OTSDUA**, or
- (c) any of the tests performed pursuant to ECP.A.6.1.1(iv) or ECP.A.6.1.1(v) do not fully demonstrate compliance with the relevant aspects of the **Grid Code, Ancillary Services Agreement** and / or **Bilateral Agreement**,

then notwithstanding the provisions above, the full testing requirements set out in this Appendix will be applied.

- ECP.A.6.1.2 The **Generator** is responsible for carrying out the tests set out in and in accordance with this Appendix and the **Generator** retains the responsibility for the safety of personnel and plant during the test. **NGET** will witness all of the tests outlined or agreed in relation to this Appendix unless **NGET** decides and notifies the **Generator** otherwise. Reactive Capability tests may be witnessed by **NGET** remotely from the **NGET** control centre. For all on site **NGET** witnessed tests the **Generator** must ensure suitable representatives from the **Generator** and / or **Power Park Module** manufacturer (if appropriate) and/or **OTSDUA** manufacturer (if appropriate) are available on site for the entire testing period. In all cases and in addition to any recording of signals conducted by **NGET** the **Generator** shall record all relevant test signals as outlined in ECP.A.4.
- ECP.A.6.1.3 In addition to the dynamic signals supplied in ECP.A.4 the **Generator** shall inform **NGET** of the following information prior to the commencement of the tests and any changes to the following, if any values change during the tests:
- (i) All relevant transformer tap numbers; and
 - (ii) Number of **Power Park Units** in operation
- ECP.A.6.1.4 The **Generator** shall submit a detailed schedule of tests to **NGET** in accordance with CP.6.3.1, and this Appendix.
- ECP.A.6.1.5 Prior to the testing of a **Power Park Module** or **OTSDUA** the **Generator** shall complete the **Integral Equipment Tests** procedure in accordance with OC.7.5
- ECP.A.6.1.6 Partial **Power Park Module** or **OTSDUA** testing as defined in ECP.A.6.2 and ECP.A.6.3 is to be completed at the appropriate stage in accordance with ECP.6, ECP6.4A, ECP6.4B.
- ECP.A.6.1.7 Full **Power Park Module** or **OTSDUA** testing as required by CP.7.2 is to be completed as defined in ECP.A.6.4 through to ECP.A.6.7
- ECP.A.6.1.8 Where **OTSDUW Arrangements** apply and prior to the **OTSUA Transfer Time** any relevant **OTSDUW Plant and Apparatus** shall be considered within the scope of testing described in this Appendix. Performance shall be assessed against the relevant Grid Code requirements for **OTSDUW Plant and Apparatus** at the **Interface Point** and other **Generator Plant and Apparatus** at the **Offshore Grid Entry Point**. This Appendix should be read accordingly.
- ECP.A.6.1.9 **NGET** will permit relaxation from the requirement ECP.A.6.2 to ECP.A.6.8 where an **Equipment Certificate** for the **Power Park Module** has been provided which details the characteristics from tests on a representative installation with the same equipment and settings and the performance of the **Power Park Module** can, in **NGET's** opinion, reasonably represent that of the installed **Power Park Modules** at that site. For **Type B, Type C** and **Type D Power Park Modules** the relevant **Equipment Certificate** must be supplied in the **Power Generating Module Document** or **Users Data File structure** as applicable.

ECP.A.6.2 Pre 20% (or <50MW) Synchronised Power Park Module Basic Voltage Control Tests

ECP.A.6.2.1 Before 20% of the **Power Park Module** (or 50MW if less) has commissioned, either voltage control test ECP.A.6.5.6(i) or (ii) must be completed in accordance with ECP.6, ECP.6A or ECP.6B. In the case of an **Offshore Power Park Module** the test must be completed by the **Generator** undertaking **OTSDUW** or the **Offshore Transmission Licensee** under STCP19-5.

ECP.A.6.2.2 In the case of an **Offshore Power Park Module** which provides all or a portion of the **Reactive Power** capability as described in ECC.6.3.2.5.2 or ECP.6.3.2.6.3 and / or voltage control requirements as described in ECC.6.3.8.5 to enable an **Offshore Transmission Licensee** to meet the requirements of **STC** Section K, the **Generator** is required to cooperate with the **Offshore Transmission Licensee** to conduct the 20% voltage control test. The results in relation to the **Offshore Power Park Module** will be assessed against the requirements in the **Bilateral Agreement**.

ECP.A.6.3 Power Park Modules with Maximum Capacity $\geq 100\text{MW}$ Pre 70% Power Park Module Tests

ECP.A.6.3.1 Before 70% but with at least 50% of the **Power Park Module** commissioned the following **Limited Frequency Sensitive** tests as detailed in ECP.A.6.6.2 must be completed.

[\(a\)](#) BC3

[\(b\)](#) BC4

ECP.A.6.4 Reactive Capability Test

ECP.A.6.4.1 This section details the procedure for demonstrating the reactive capability of an **Onshore Power Park Module** or an **Offshore Power Park Module** or **OTSDUA** which provides all or a portion of the **Reactive Power** capability as described in ECC.6.3.2.5.2 or ECP.6.3.2.6.3 as applicable (for the avoidance of doubt, an **Offshore Power Park Module** which does not provide part of the **Offshore Transmission Licensee Reactive Power** capability as described in ECC.6.3.2.5.1 and ECP.6.3.2.6.1 should complete the **Reactive Power** transfer / voltage control tests as per section ECP.A.6.8). These tests should be scheduled at a time where there are at least 95% of the **Power Park Units** within the **Power Park Module** in service. There should be sufficient MW resource forecasted in order to generate at least 85% of **Maximum Capacity** of the **Power Park Module**.

ECP.A.6.4.2 The tests shall be performed by modifying the voltage set-point of the voltage control scheme of the **Power Park Module** or **OTSDUA** by the amount necessary to demonstrate the required reactive range. This is to be conducted for the operating points and durations specified in ECP.A.6.4.5.

ECP.A.6.4.3 An **Embedded Generator** or **Embedded Generator** undertaking **OTSDUW** should liaise with the relevant **Network Operator** to ensure

the following tests will not have an adverse impact upon the **Network Operator's System** as per OC.7.5. In situations where the tests have an adverse impact upon the **Network Operator's System** NGET will only require demonstration within the acceptable limits of the **Network Operator**. For the avoidance of doubt, these tests do not negate the requirement to produce a complete **Power Park Module** or **OTSDUA** performance chart as specified in OC2.4.2.1

ECP.A.6.4.4 In the case where the **Reactive Power** metering point is not at the same location as the **Reactive Power** capability requirement, then an equivalent **Reactive Power** capability for the metering point shall be agreed between the **Generator** and **NGET**.

ECP.A.6.4.5 The following tests shall be completed:

- (i) Operation in excess of 60% **Maximum Capacity** and maximum continuous lagging **Reactive Power** for 30 minutes.
- (ii) Operation in excess of 60% **Maximum Capacity** and maximum continuous leading **Reactive Power** for 30 minutes.
- (iii) Operation at 50% **Maximum Capacity** and maximum continuous leading **Reactive Power** for 30 minutes.
- (iv) Operation at 20% **Maximum Capacity** and maximum continuous leading **Reactive Power** for 60 minutes.
- (v) Operation at 20% **Maximum Capacity** and maximum continuous lagging **Reactive Power** for 60 minutes.
- (vi) Operation at less than 20% **Maximum Capacity** and unity **Power Factor** for 5 minutes. This test only applies to systems which do not offer voltage control below 20% of **Maximum Capacity**.
- (vii) Operation at the lower of the **Minimum Stable Operating Level** or 0% **Maximum Capacity** and maximum continuous leading **Reactive Power** for 5 minutes. This test only applies to systems which offer voltage control below 20% and hence establishes actual capability rather than required capability.
- (viii) Operation at the lower of the **Minimum Stable Operating Level** or 0% **Maximum Capacity** and maximum continuous lagging **Reactive Power** for 5 minutes. This test only applies to systems which offer voltage control below 20% and hence establishes actual capability rather than required capability.

ECP.A.6.4.6 Within this ECP lagging **Reactive Power** is the export of **Reactive Power** from the **Power Park Module** to the **Total System** and leading **Reactive Power** is the import of **Reactive Power** from the **Total System** to the **Power Park Module** or **OTSDUA**.

ECP.A.6.5 Voltage Control Tests

- ECP.A.6.5.1 This section details the procedure for conducting voltage control tests on **Onshore Power Park Modules** or **OTSDUA** or an **Offshore Power Park Module** which provides all or a portion of the voltage control capability as described in ECC.6.3.8.5 (for the avoidance of doubt, **Offshore Power Park Modules** which do not provide part of the **Offshore Transmission Licensee** voltage control capability as described in CC6.3.8.5 should complete the **Reactive Power** transfer / voltage control tests as per section ECP.A.6.8). These tests should be scheduled at a time when there are at least 95% of the **Power Park Units** within the **Power Park Module** in service. There should be sufficient MW resource forecasted in order to generate at least 65% of **Maximum Capacity** of the **Onshore Power Park Module**. An **Embedded Generator** or **Embedded Generators** undertaking **OTSDUW** should also liaise with the relevant **Network Operator** to ensure all requirements covered in this section will not have a detrimental effect on the **Network Operator's System**.
- ECP.A.6.5.2 The voltage control system shall be perturbed with a series of step injections to the **Power Park Module** voltage Setpoint, and where possible, multiple up-stream transformer taps. In the case of an **Offshore Power Park Module** providing part of the **Offshore Transmission Licensee** voltage control capability this may require a series of step injections to the voltage Setpoint of the **Offshore Transmission Licensee** control system.
- ECP.A.6.5.3 For steps initiated using network tap changers the **Generator** will need to coordinate with **NGET** or the relevant **Network Operator** as appropriate. The time between transformer taps shall be at least 10 seconds as per ECP.A.6.5 Figure 1.
- ECP.A.6.5.4 For step injection into the **Power Park Module** or **OTSDUA** voltage Setpoint, steps of $\pm 1\%$ and $\pm 2\%$ (or larger if required by NGET) shall be applied to the voltage control system Setpoint summing junction. The injection shall be maintained for 10 seconds as per ECP.A.6.5 Figure 2.
- ECP.A.6.5.5 Where the voltage control system comprises of discretely switched plant and apparatus additional tests will be required to demonstrate that its performance is in accordance with **Grid Code** and **Bilateral Agreement** requirements.

ECP.A.6.5.6 Tests to be completed:

Formatted: Keep with next

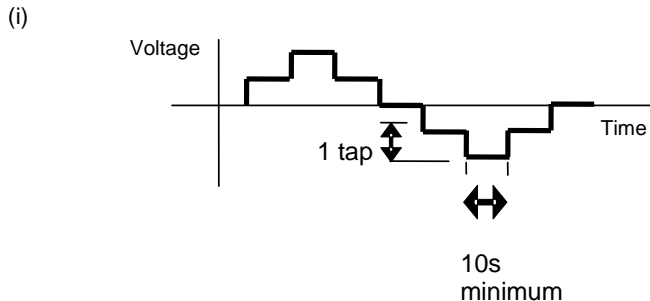

ECP.A.6.5 Figure 1 – Transformer tap sequence for voltage control tests

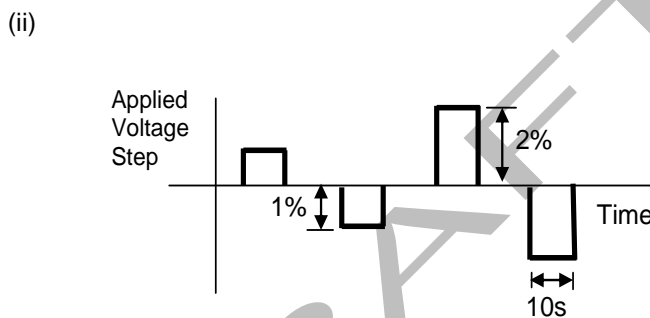

ECP.A.6.5 Figure 2 – Step injection sequence for voltage control tests

ECP.A.6.5.7 In the case of **OTSDUA** where the **Bilateral Agreement** specifies additional damping facilities additional testing to demonstrate these damping facilities may be required.

ECP.A.6.6 Frequency Response Tests

ECP.A.6.6.1 This section describes the procedure for performing frequency response testing on a **Power Park Module**. These tests should be scheduled at a time where there are at least 95% of the **Power Park Units** within the **Power Park Module** in service. There should be sufficient MW resource forecasted in order to generate at least 65% of **Maximum Capacity** of the **Power Park Module**.

ECP.A.6.6.2 The frequency controller shall be in **Frequency Sensitive Mode** or **Limited Frequency Sensitive Mode** as appropriate for each test. Simulated frequency deviation signals shall be injected into the frequency controller setpoint/feedback summing junction. If the injected frequency signal replaces rather than sums with the real system frequency signal then the additional tests outlined in ECP.A.6.6.6 shall be performed with the **Power Park Module** or **Power Park Unit** in normal **Frequency Sensitive Mode** monitoring actual system frequency, over a period of at least 10 minutes. The aim

of this additional test is to verify that the control system correctly measures the real system frequency for normal variations over a period of time.

ECP.A.6.6.3 In addition to the frequency response requirements it is necessary to demonstrate the **Power Park Module** ability to deliver a requested steady state power output which is not impacted by power source variation as per ECC.6.3.9. This test shall be conducted in **Limited Frequency Sensitive Mode** at a part-loaded output for a period of 10 minutes as per ECP.A.6.6.6.

Preliminary Frequency Response Testing

ECP.A.6.6.4 Prior to conducting the full set of tests as per ECP.A.6.6.6, **Generators** are required to conduct the preliminary set of tests below to confirm the frequency injection method is correct and the plant control performance is within expectation. The test numbers refer to Figure 1 below. The test should be conducted when sufficient MW resource is forecasted in order to generate at least 65% of **Maximum Capacity** of the **Power Park Module**. The following frequency injections shall be applied when operating at module load point 4.

Test No (Figure1)	Frequency Injection	Notes
8	<ul style="list-style-type: none"> Inject -0.5Hz frequency fall over 10 sec Hold for a further 20 sec At 30 sec from the start of the test, Inject a +0.3Hz frequency rise over 30 sec. Hold until conditions stabilise Remove the injected signal <u>as a ramp over 10 seconds</u> 	
13	<ul style="list-style-type: none"> Inject - 0.5Hz frequency fall over 10 sec Hold until conditions stabilise Remove the injected signal <u>as a ramp over 10 seconds</u> 	
14	<ul style="list-style-type: none"> Inject +0.5Hz frequency rise over 10 sec Hold until conditions stabilise Remove the injected signal <u>as a ramp over 10 seconds</u> 	
H	<ul style="list-style-type: none"> Inject - 0.5Hz frequency fall as a stepchange Hold until conditions stabilise Remove the injected signal <u>as a stepchange</u> 	
I	<ul style="list-style-type: none"> Inject +0.5Hz frequency rise as a stepchange Hold until conditions stabilise Remove the injected signal <u>as a stepchange</u> 	

Formatted Table

ECP.A.6.6.5 The recorded results (e.g. Finj, MW and control signals) should be sampled at a minimum rate of 1 Hz to allow **NGET** to assess the plant performance from the initial transients (seconds) to the final steady state conditions (5-15 minutes depending on the plant design). This is not witnessed by **NGET**. The **Generator** shall supply the recordings including data to **NGET** in an electronic spreadsheet format. Results shall be legible, identifiable by labelling, and shall have appropriate scaling.

Full Frequency Response Testing Schedule Witnessed by **NGET**

ECP.A.6.6.6 The tests are to be conducted at a number of different Module Load Points (MLP). In the case of a **Power Park Module** the module load points are conducted as shown below unless agreed otherwise by **NGET**.

Module Load Point 6 (Maximum Export Limit)	100% MEL
Module Load Point 5	90% MEL
Module Load Point 4 (Mid point of Operating Range)	80% MEL
Module Load Point 3	MRL+20%
Module Load Point 2 Lower of MRL +10% or Minimum Stable Operating Level	MRL+10% or MSOL
Module Load Point 1 (Minimum regulating level)	MRL

Formatted Table

Formatted: Font: Bold

ECP.A.6.6.7 The tests are divided into the following two types;

- (i) Frequency response compliance and volume tests as per ECP.A.6.6.6. Figure 1. These tests consist of frequency profile and ramp tests and adjustments to target frequency setpoint as per ECP.A.6.6.6 Figure 3.-
- (ii) System islanding and step response tests as shown by ECP.A.6.6.6. Figure 2.
- (iii) Frequency response tests in **Limited Frequency Sensitive Mode (LFSM)** to demonstrate **LFSM-O** and **LFSM-U** capability as shown by ECP.A.6.6.6 Figure 2.

ECP.A.6.6.8 There should be sufficient time allowed between tests for control systems to reach steady state (depending on available power resource). Where the diagram states 'HOLD' the current injection should be maintained until the **Active Power** (MW) output of the **Power Park Module** has stabilised. All frequency response tests should be removed over the same timescale for which they were applied. **NGET** may require repeat tests should the response volume be affected by the available power, or if tests give unexpected results.

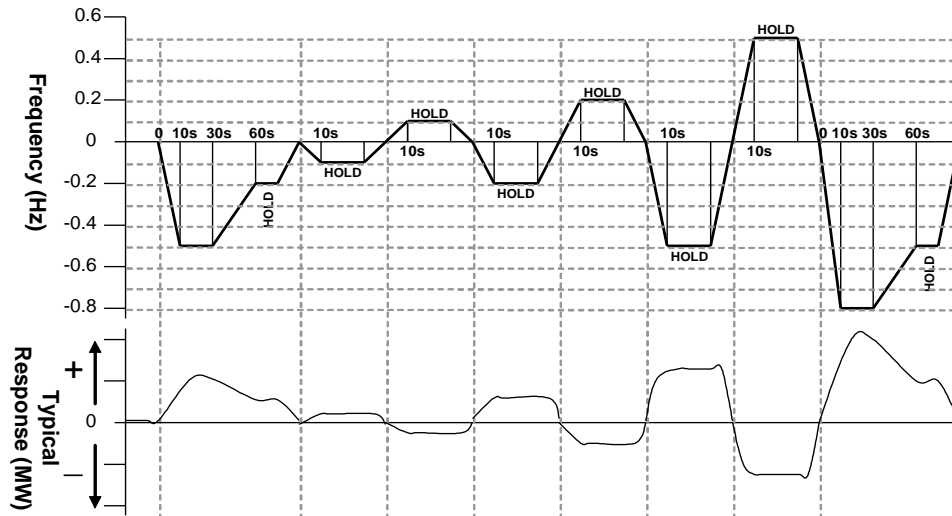

Load Point	LF Event Profile 1	LF Ramp -0.1Hz	HF Ramp +0.1Hz	LF Ramp -0.2Hz	HF Ramp +0.2Hz	LF Ramp -0.5Hz	HF Ramp +0.5Hz	LF Event Profile 2
MLP6			1	2	3		4	
MLP5	5			6			7	
MLP4	8	9	10	11	12	13	14	
MLP3	15						16	17
MLP2	18			19	20	21		22
MLP1	23			24	25			26

ECP.A.6.6. Figure 1 – Frequency Response Capability FSM Ramp Volume Response tests

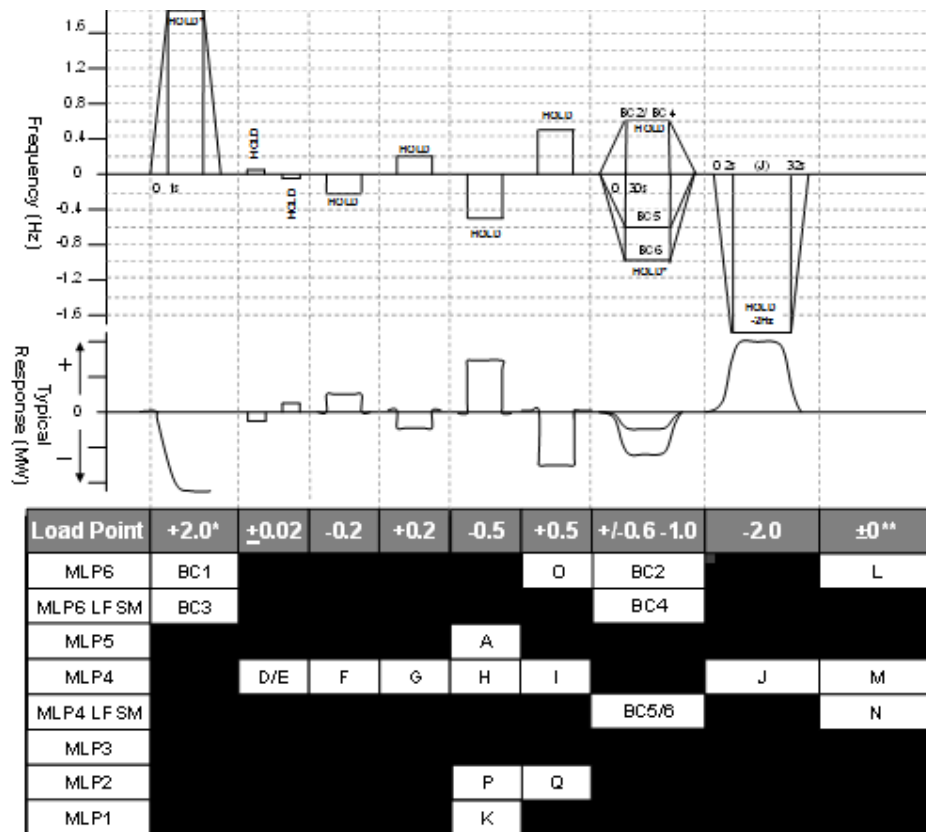

ECP.A.6.6. Figure 2 – Frequency Response Capability LFSM-O, LFSM-U, FSM Step Response System islanding and step response tests

* This will generally be +2.0Hz unless an injection of this size causes a reduction in plant output that takes the operating point below **Minimum Stable Operating Level** in which case an appropriate injection should be calculated in accordance with the following:
 For example 0.9Hz is needed to take an initial output 65% to a final output of 20%. If the initial output was not 65% and the **Minimum Stable Operating Level** is not 20% then the injected step should be adjusted accordingly as shown in the example given below

Initial Output 65%
Minimum Stable Operating Level 20%
 Frequency Controller Droop 4%
 Frequency to be injected = $(0.65-0.20) \times 0.04 \times 50 = 0.9\text{Hz}$

** Tests L and M in Figure 2 shall be conducted if in this range of tests the system frequency feedback signal is replaced by the injection signal rather than the injection signal being added to the system frequency signal. The tests will consist of monitoring the **Power Park Module** in **Frequency Sensitive Mode** during normal system frequency variations without applying any injection. Test N in Figure 2 shall be conducted in all cases. All three tests should be conducted for a period of at least 10 minutes.

ECP.A.6.6.9 The target frequency adjustment facility should be demonstrated from the normal control point within the range of 49.9Hz to 50.1Hz by step changes to the target frequency setpoint as indicated in ECP.A.6.6 Figure 3.-

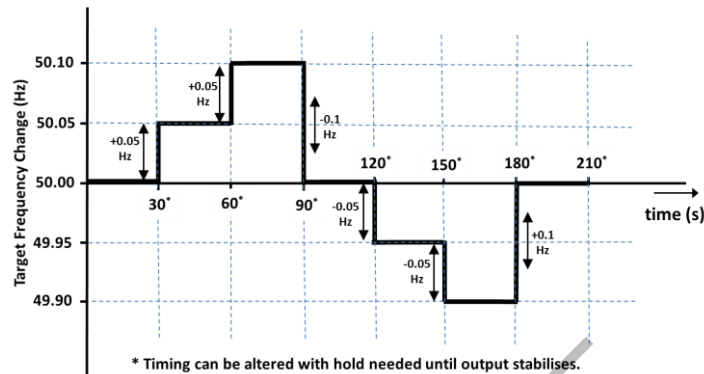

ECP.A.6.6. Figure 3 – Target Frequency setting changes

ECP.A.6.7 Fault Ride Through Testing

ECP.A.6.7.1 This section describes the procedure for conducting fault ride through tests on a single **Power Park Unit**– as required by ECP.7.2.2(d).

ECP.A.6.7.2 The test circuit will utilise the full **Power Park Unit** with no exclusions (e.g. in the case of a wind turbine it would include the full wind turbine structure) and shall be conducted with sufficient resource available to produce at least 95% of the **Maximum Capacity** of the **Power Park Unit**. The test will comprise of a number of controlled short circuits applied to a test network to which the **Power Park Unit** is connected, typically comprising of the **Power Park Unit** transformer and a test impedance to shield the connected network from voltage dips at the **Power Park Unit** terminals.

ECP.A.6.7.3 In each case the tests should demonstrate the minimum voltage at the **Power Park Unit** terminals or **High Voltage** side of the **Power Park Unit** transformer which the **Power Park Unit** can withstand for the length of time specified in ECP.A.6.7.5. Any test results provided to **NGET** should contain sufficient data pre and post fault in order to determine steady state values of all signals, and the power recovery timescales.

ECP.A.6.7.4 In addition to the signals outlined in ECP.A.4.2. the following signals from either the **Power Park Unit** terminals or **High Voltage** side of the **Power Park Unit** transformer should be provided for this test only:

- (i) Phase voltages
- (ii) Positive phase sequence and negative phase sequence voltages
- (iii) Phase currents
- (iv) Positive phase sequence and negative phase sequence currents

- (v) Estimate of **Power Park Unit** negative phase sequence impedance
- (vi) MW – **Active Power** at the power generating module.
- (vii) MVar – **Reactive Power** at the power generating module.
- (viii) Mechanical Rotor Speed
- (ix) Real / reactive, current / power Setpoint as appropriate
- (x) Fault ride through protection operation (e.g. a crowbar in the case of a doubly fed induction generator)
- (xi) Any other signals relevant to the control action of the fault ride through control deemed applicable for model validation.

At a suitable frequency rate for fault ride through tests as agreed with **NGET**.

ECP.A.6.7.5 The tests should be conducted for the times and fault types indicated in ECC.6.3.15 as applicable.

ECP.A.6.8 Reactive Power Transfer / Voltage Control Tests for **Offshore Power Park Modules**

Formatted: Font: Not Bold

ECP.A.6.8.1 In the case of an **Offshore Power Park Module** which provides all or a portion of the **Reactive Power** capability as described in ECP.6.3.2.5.2 or ECP.6.3.6.3 and / or voltage control requirements as described in ECC.6.3.8.5 to enable an **Offshore Transmission Licensee** to meet the requirements of **STC** Section K, the testing, will comprise of the entire control system responding to changes at the onshore **Interface Point**. Therefore the tests in this section ECP.A.6.8 will not apply. The **Generator** shall cooperate with the relevant **Offshore Transmission Licensee** to facilitate these tests as required by **NGET**. The testing may be combined with testing of the corresponding **Offshore Transmission Licensee** requirements under the **STC**. The results in relation to the **Offshore Power Park Module** will be assessed against the requirements in the **Bilateral Agreement**.

ECP.A.6.8.2 In the case of an **Offshore Power Park Module** which does not provide part of the **Offshore Transmission Licensee Reactive Power** capability the following procedure for conducting **Reactive Power** transfer control tests on **Offshore Power Park Modules** and / or voltage control system as per CC6.3.2(e)(i) and CC6.3.2(e)(ii) apply. These tests should be carried out prior to 20% of the **Power Park Units** within the **Offshore Power Park Module** being synchronised, and again when at least 95% of the **Power Park Units** within the **Offshore Power Park Module** in service. There should be sufficient power resource forecast to generate at least 85% of the **Maximum Capacity** of the **Offshore Power Park Module**.

ECP.A.6.8.3 The **Reactive Power** control system shall be perturbed by a series of system voltage changes and changes to the **Active Power** output of the **Offshore Power Park Module**.

ECP.A.6.8.4 System voltage changes should be created by a series of multiple upstream transformer taps. The **Generator** should coordinate with **NGET** or the relevant **Network Operator** in order to conduct the

required tests. The time between transformer taps should be at least 10 seconds as per ECP.A.6.8 Figure 1.

ECP.A.6.8.5 The active power output of the **Offshore Power Park Module** should be varied by applying a sufficiently large step to the frequency controller Setpoint/feedback summing junction to cause a 10% change in output of the **Maximum Capacity** of the **Offshore Power Park Module** in a time not exceeding 10 seconds. This test does not need to be conducted provided that the frequency response tests as outlined in ECP.A.6.6 are completed.

ECP.A.6.8.6 The following diagrams illustrate the tests to be completed:

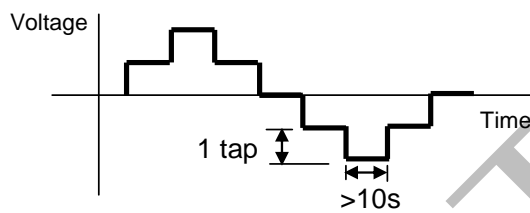

ECP.A.6.8 Figure 1 – Transformer tap sequence for reactive transfer tests

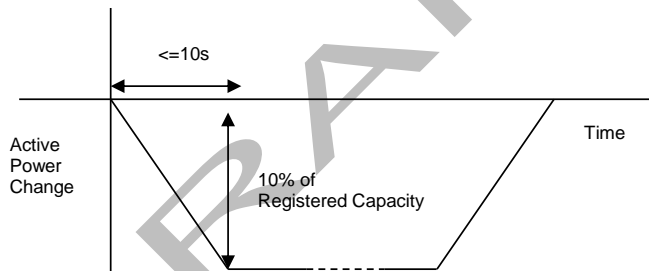

ECP.A.6.8 Figure 2 – Active Power ramp for reactive transfer tests

APPENDIX 7

COMPLIANCE TESTING FOR HVDC EQUIPMENT

| ECP.A.7.1 SCOPE

Formatted: Underline

ECP.A.7.1.1 This Appendix outlines the general testing requirements for **HVDC System Owners** to demonstrate compliance with the relevant aspects of the **Grid Code, Ancillary Services Agreement** and **Bilateral Agreement**. The tests specified in this Appendix will normally be sufficient to demonstrate compliance however **NGET** may:

- i) agree an alternative set of tests provided **NGET** deem the alternative set of tests sufficient to demonstrate compliance with the **Grid Code, Ancillary Services Agreement** and **Bilateral Agreement**; and/or
- ii) require additional or alternative tests if information supplied to **NGET** during the compliance process suggests that the tests in this Appendix will not fully demonstrate compliance with the relevant section of the **Grid Code, Ancillary Services Agreement** or **Bilateral Agreement**; and/or
- iii) require additional tests if control functions to improve damping of power system oscillations and/or subsynchronous resonance torsional oscillations required by the **Bilateral Agreement** or included in the control scheme and active; and/or
- iv) agree a reduced set of tests for subsequent **HVDC Equipment** following successful completion of the first **HVDC Equipment** tests in the case of a installation comprising of two or more **HVDC Systems** or **DC Connected Power Park Modules** which **NGET** reasonably considers to be identical.

If:

- (a) the tests performed pursuant to ECP.A.7.1.1(iv) in respect of subsequent **HVDC Systems** or **DC Connected Power Park Modules** do not replicate the full tests for the first **HVDC Equipment** , or
- (b) any of the tests performed pursuant to ECP.A.7.1.1(iv) do not fully demonstrate compliance with the relevant aspects of the **Grid Code, Ancillary Services Agreement** and / or **Bilateral**

ECP.A.7.1.2 The **HVDC System Owner** is responsible for carrying out the tests set out in and in accordance with this Appendix and the **HVDC System Owner** retains the responsibility for the safety of personnel and plant during the test. The **HVDC System Owner** is responsible for ensuring that suitable arrangements are in place with the **Externally Interconnected System Operator** to facilitate testing. **NGET** will witness all of the tests outlined or agreed in relation to this Appendix unless **NGET** decides and notifies the **HVDC System Owner** otherwise. Reactive Capability tests if required, may be witnessed by **NGET** remotely from the **NGET** control centre. For all on site **NGET**

witnessed tests the **HVDC System Owner** must ensure suitable representatives from the **HVDC System Owner** and / or **HVDC Equipment** manufacturer (if appropriate) are available on site for the entire testing period. In all cases and in addition to any recording of signals conducted by **NGET** the **HVDC System Owner** shall record all relevant test signals as outlined in ECP.A.4.

ECP.A.7.1.3 In addition to the dynamic signals supplied in ECP.A.4 the **HVDC System Owner** shall inform **NGET** of the following information prior to the commencement of the tests and any changes to the following, if any values change during the tests:

(i) All relevant transformer tap numbers.

ECP.A.7.1.4 The **HVDC System Owner** shall submit a detailed schedule of tests to **NGET** in accordance with CP.6.3.1, and this Appendix.

ECP.A.7.1.5 Prior to the testing of **HVDC Equipment** the **HVDC System Owner** shall complete the **Integral Equipment Tests** procedure in accordance with OC.7.5

ECP.A.7.1.6 Full **HVDC Equipment** testing as required by ECP.7.2 is to be completed as defined in ECP.A.7.2 through to ECP.A.7.5

ECP.A.7.1.7 **NGET** will permit relaxation from the requirement ECP.A.7.2 to ECP.A.7.5 where an **Equipment Certificate** for **HVDC Equipment** has been provided which details the characteristics from tests on a representative installation with the same equipment and settings and the performance of the **HVDC Equipment** can, in **NGET's** opinion, reasonably represent that of the installed **HVDC Equipment** at that site. The relevant **Equipment Certificate** must be supplied in the **Users Data File structure**.

ECP.A.7.2 Reactive Capability Test

ECP.A.7.2.1 This section details the procedure for demonstrating the reactive capability of **HVDC Equipment**. These tests should be scheduled at a time where there are sufficient MW resource forecasted in order to import and export full **Maximum Capacity** of the **HVDC Equipment**.

ECP.A.7.2.2 The tests shall be performed by modifying the voltage set-point of the voltage control scheme of the **HVDC Equipment** by the amount necessary to demonstrate the required reactive range. This is to be conducted for the operating points and durations specified in ECP.A.7.2.5.

ECP.A.7.2.3 **Embedded HVDC System Owners** should liaise with the relevant **Network Operator** to ensure the following tests will not have an adverse impact upon the **Network Operator's System** as per OC.7.5. In situations where the tests have an adverse impact upon the **Network Operator's System** **NGET** will only require demonstration within the acceptable limits of the **Network Operator**. For the avoidance of doubt, these tests do not negate the requirement to produce a complete **HVDC Equipment** performance chart as specified in OC2.4.2.1

ECP.A.7.2.4 In the case where the **Reactive Power** metering point is not at the same location as the **Reactive Power** capability requirement, then an equivalent **Reactive Power** capability for the metering point shall be agreed between the **HVDC System Owner** and **NGET**.

ECP.A.7.2.5 The following tests shall be completed for both importing and exporting of Active Power for a **DC Converter**:

- (i) Operation at **Maximum Capacity** and maximum continuous lagging **Reactive Power** for 60 minutes.
- (ii) Operation at **Maximum Capacity** and maximum continuous leading **Reactive Power** for 60 minutes.
- (iii) Operation at 50% **Maximum Capacity** and maximum continuous leading **Reactive Power** for 60 minutes.
- (iv) Operation at 50% **Maximum Capacity** and maximum continuous lagging **Reactive Power** for 60 minutes.
- (v) Operation at **Minimum Capacity** and maximum continuous leading **Reactive Power** for 60 minutes.
- (vi) Operation at **Minimum Capacity** and maximum continuous lagging **Reactive Power** for 60 minutes.

ECP.A.7.2.6 For the avoidance of doubt, lagging **Reactive Power** is the export of **Reactive Power** from the **HVDC Equipment** to the **Total System** and leading **Reactive Power** is the import of **Reactive Power** from the **Total System** to the **HVDC Equipment**.

ECP.A.7.3 Not Used

ECP.A.7.4 Voltage Control Tests

ECP.A.7.4.1 This section details the procedure for conducting voltage control tests on **HVDC Equipment**. These tests should be scheduled at a time where there are sufficient MW resource in order to import and export **Maximum Capacity** of the **HVDC Equipment**. An **Embedded HVDC System Owner** should also liaise with the relevant **Network Operator** to ensure all requirements covered in this section will not have a detrimental effect on the **Network Operator's System**.

ECP.A.7.4.2 The voltage control system shall be perturbed with a series of step injections to the **HVDC Equipment** voltage Setpoint, and where possible, multiple up-stream transformer taps.

ECP.A.7.4.3 For steps initiated using network tap changers the **HVDC System Owner** will need to coordinate with **NGET** or the relevant **Network Operator** as appropriate. The time between transformer taps shall be at least 10 seconds as per ECP.A.7.4 Figure 1.

ECP.A.7.4.4 For step injection into the **HVDC Equipment** voltage Setpoint, steps of $\pm 1\%$ and $\pm 2\%$ shall be applied to the voltage control system Setpoint summing junction. The injection shall be maintained for 10 seconds as per ECP.A.7.4 Figure 2.

ECP.A.7.4.5 Where the voltage control system comprises of discretely switched plant and apparatus additional tests will be required to demonstrate that its performance is in accordance with **Grid Code** and **Bilateral Agreement** requirements.

ECP.A.7.4.6 Tests to be completed:

(i)

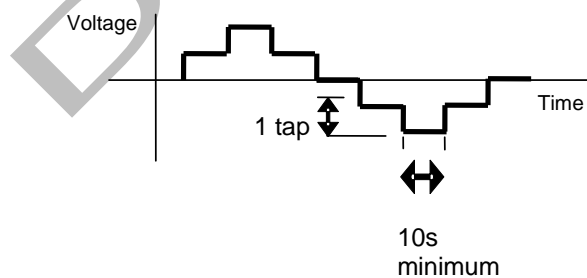

ECP.A.7.4 Figure 1 – Transformer tap sequence for voltage control tests

Formatted: Keep with next

(ii)

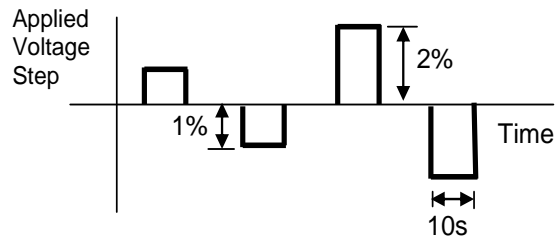

ECP.A.7.4 Figure 2 – Step injection sequence for voltage control tests

ECP.A.7.5 Frequency Response Tests

ECP.A.7.5.1 This section describes the procedure for performing frequency response testing on **HVDC Equipment**. These tests should be scheduled at a time where there are sufficient MW resource in order to import and export full **Maximum Capacity** of the **HVDC Equipment**. The **HVDC System Owner** is responsible for ensuring that suitable arrangements are in place with the **Externally Interconnected System Operator** to facilitate the active power changes required by these tests

ECP.A.7.5.2 The frequency controller shall be in **Frequency Sensitive Mode** or **Limited Frequency Sensitive Mode** as appropriate for each test. Simulated frequency deviation signals shall be injected into the frequency controller Setpoint/feedback summing junction. If the injected frequency signal replaces rather than sums with the real system frequency signal then the additional tests outlined in ECP.A.7.5.6 shall be performed with the **HVDC Equipment** in normal **Frequency Sensitive Mode** monitoring actual system frequency, over a period of at least 10 minutes. The aim of this additional test is to verify that the control system correctly measures the real system frequency for normal variations over a period of time.

ECP.A.7.5.3 In addition to the frequency response requirements it is necessary to demonstrate the **HVDC Equipment** ability to deliver a requested steady state power output which is not impacted by power source variation as per ECC.6.3.9. This test shall be conducted in **Limited Frequency Sensitive Mode** at a part-loaded output for a period of 10 minutes as per ECP.A.7.5.6.

Preliminary Frequency Response Testing

ECP.A.7.5.4 Prior to conducting the full set of tests as per ECP.A.7.5.6, **HVDC System Owners** are required to conduct a preliminary set of tests below to confirm the frequency injection method is correct and the plant control performance is within expectation. The test numbers refer to Figure 1 below. These tests should be scheduled at a time where there are sufficient MW resource in order to export full

Maximum Capacity from the HVDC Equipment . The following frequency injections shall be applied when operating at module load point 4.

DRAFT

Test No (Figure1)	Frequency Injection	Notes
8	<ul style="list-style-type: none"> Inject -0.5Hz frequency fall over 10 sec Hold for a further 20 sec At 30 sec from the start of the test, Inject a +0.3Hz frequency rise over 30 sec. Hold until conditions stabilise Remove the injected signal <u>as a ramp over 10 seconds</u> 	
13	<ul style="list-style-type: none"> Inject - 0.5Hz frequency fall over 10 sec Hold until conditions stabilise Remove the injected signal <u>as a ramp over 10 seconds</u> 	
14	<ul style="list-style-type: none"> Inject +0.5Hz frequency rise over 10 sec Hold until conditions stabilise Remove the injected signal <u>as a ramp over 10 seconds</u> 	
H	<ul style="list-style-type: none"> Inject - 0.5Hz frequency fall as a stepchange Hold until conditions stabilise Remove the injected signal <u>as a stepchange</u> 	
I	<ul style="list-style-type: none"> Inject +0.5Hz frequency rise as a stepchange Hold until conditions stabilise Remove the injected signal <u>as a stepchange</u> 	

Formatted Table

ECP.A.7.5.5 The recorded results (e.g. Finj, MW and control signals) should be sampled at a minimum rate of 1 Hz to allow **NGET** to assess the plant performance from the initial transients (seconds) to the final steady state conditions (5-15 minutes depending on the plant design). This is not witnessed by **NGET**. The **HVDC System Owner** shall supply the recordings including data to **NGET** in an electronic spreadsheet format. Results shall be legible, identifiable by labelling, and shall have appropriate scaling.

Full Frequency Response Testing Schedule Witnessed by **NGET**

ECP.A.7.5.6 The tests are to be conducted at a number of different Module Load Points (MLP). In the case of **HVDC Equipment** the load points are conducted as shown below unless agreed otherwise by **NGET**.

Module Load Point 6 (Maximum Export Limit)	100% MEL
Module Load Point 5	90% MEL
Module Load Point 4 (Mid point of Operating Range)	80% MEL
Module Load Point 3	MRL+20%
Module Load Point 2	MRL+10%
Module Load Point 1 (Minimum regulating level)	MRL

ECP.A.7.5.7 The tests are divided into the following two types;

- (i) Frequency response compliance and volume tests as per ECP.A.7.5. Figure 1. These tests consist of frequency profile and ramp tests and adjustments to target frequency setpoint as per ECP.A.7.5 Figure 3-
- (ii) System islanding and step response tests as shown by ECP.A.7.5 Figure 2

ECP.A.7.5. Fig 1 and 2 are shown for the Importing of Active Power, simulated frequency polarity should be reversed when exporting Active Power.

ECP.A.7.5.8 There should be sufficient time allowed between tests for control systems to reach steady state (depending on available power resource). Where the diagram states 'HOLD' the current injection should be maintained until the **Active Power** (MW) output of the **HVDC Equipment** has stabilised. All frequency response tests should be removed over the same timescale for which they were applied. **NGET** may require repeat tests should the response volume be affected by the available power, or if tests give unexpected results.

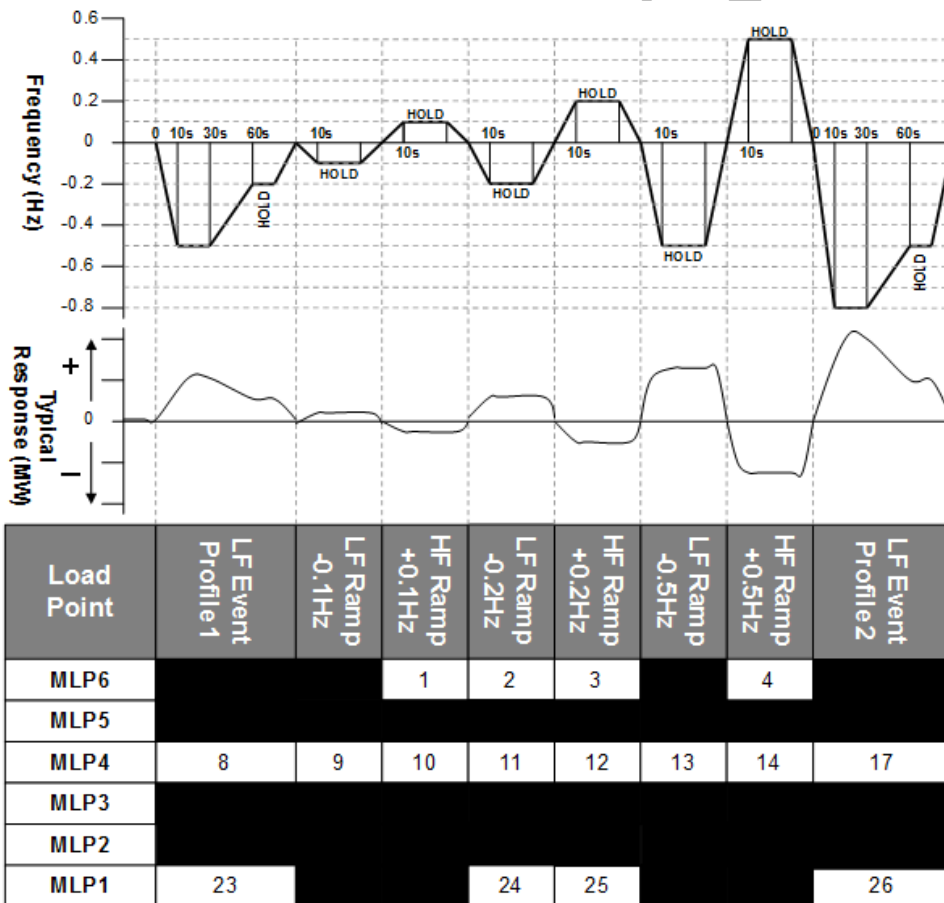

ECP.A.7.5. Figure 1 – Frequency Response Capability FSM Ramp Response volume tests

DRAFT

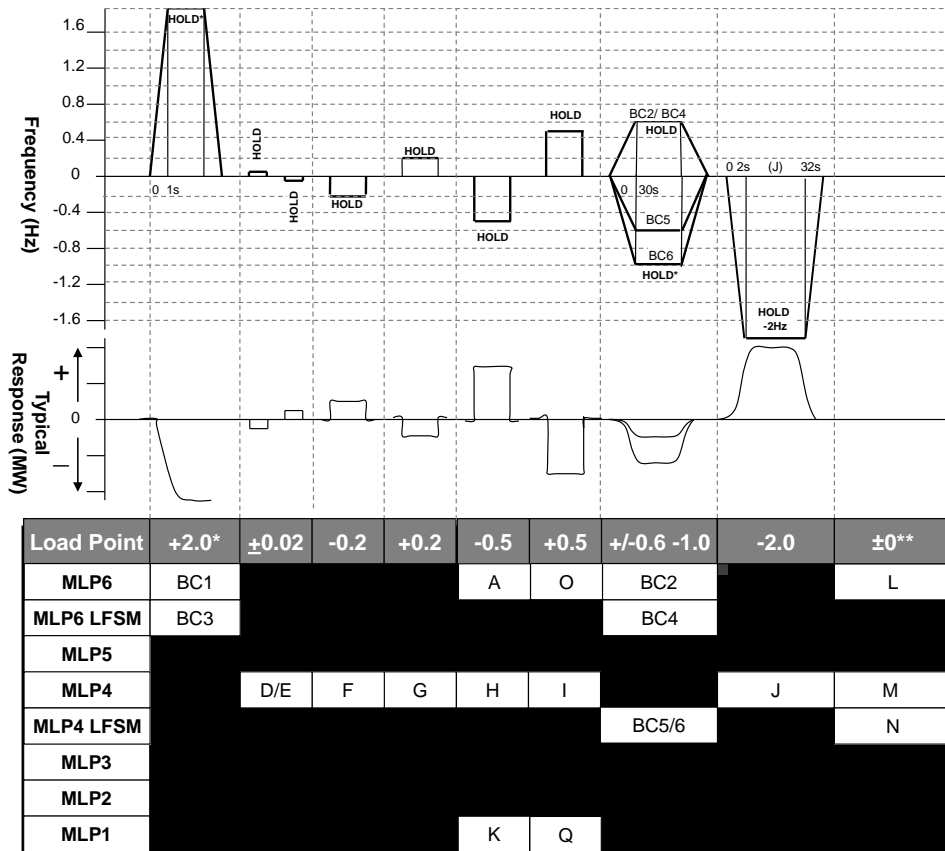

ECP.A.7.5. Figure 2 – Frequency Response Capability LFSM-O, LFSM-U, FSM Step R System islanding and step response tests

Formatted: Centered

* This will generally be +2.0Hz unless an injection of this size causes a reduction in plant output that takes the operating point below **Minimum Capacity** in which case an appropriate injection should be calculated in accordance with the following:

For example 0.9Hz is needed to take an initial output 65% to a final output of 20%. If the initial output was not 65% and the **Minimum Capacity** is not 20% then the injected step should be adjusted accordingly as shown in the example given below

Initial Output	65%
Minimum Capacity	20%
Frequency Controller Droop	4%
Frequency to be injected =	$(0.65-0.20) \times 0.04 \times 50 = 0.9\text{Hz}$

** Tests L and M in Figure 2 shall be conducted if in this range of tests the system frequency feedback signal is replaced by the injection signal rather than the injection signal being added to the system frequency signal. The tests will consist of monitoring the **HVDC Equipment** in **Frequency Sensitive Mode** during normal system frequency variations without applying any injection. Test N in Figure 2

shall be conducted in all cases. All three tests should be conducted for a period of at least 10 minutes.

ECP.A.7.5.9 The target frequency adjustment facility should be demonstrated from the normal control point within the range of 49.9Hz to 50.1Hz by step changes to the target frequency setpoint as indicated in ECP.A.7.5 Figure 3.-

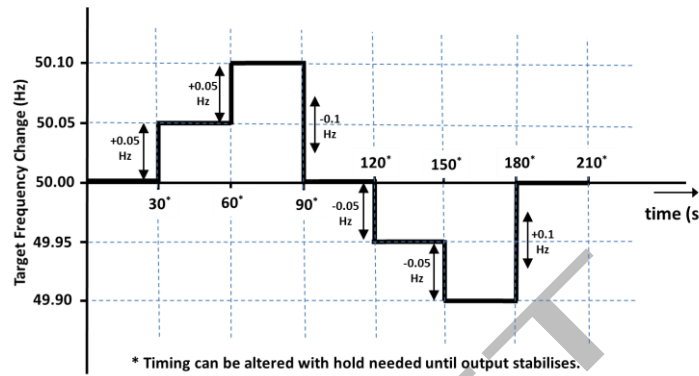

Formatted: Centered, Indent: Left: 1.27 cm

ECP.A.7.5. Figure 3 – Target Frequency setting changes

Formatted: Centered

< End of ECP >

DRAFT