



# Electricity Ten Year Statement 2017

UK electricity transmission



---

## How to use this interactive document

To help you find the information you need quickly and easily we have published the *ETYS* as an interactive document.

---

### Home

This will take you to the contents page. You can click on the titles to navigate to a section.

### Arrows

Click on the arrows to move backwards or forwards a page.



### A to Z

You will find a link to the glossary on each page.



### Hyperlinks

Hyperlinks are underlined and highlighted in the chapter colour throughout the report. You can click on them to access further information.

---

## We are in the midst of an energy revolution.

The economic landscape, developments in technology and consumer behaviour are changing at an unprecedented rate, creating more opportunities than ever for our industry.

---



**Our *Electricity Ten Year Statement*, along with our other System Operator publications, aims to encourage and inform debate, leading to changes that ensure a secure, sustainable and affordable energy future.**

Your views, knowledge and insight have shaped the publication. Thank you for this valuable input over the past year.

Our 2017 analysis has used our latest future energy scenarios, which we've developed with stakeholder and industry input. Now our 2017 analysis is complete, we have been able to draw out some important messages.

We're seeing the closures of fossil-fuelled generation, an influx of wind generation, rising electric vehicle and heat pump demand, and increasing export requirements via interconnectors. These changes are leading to high north-to-south transmission flows across Scotland and much of the north of England to meet demand in the Midlands and the south. The ongoing Western HVDC project to link south-west Scotland to north Wales when commissioned will add a significant 2,200MW to the capability of our network to help manage the high flows. However, future network flow patterns and stresses mean we need to continue to ensure our grid is always fit for purpose, and to develop the whole transmission system across the whole of Great Britain in an efficient way.

We will assess the options for network reinforcement through our *Network Options Assessment (NOA)*. The *NOA* aims to make sure that the transmission system is continuously developed in a timely, economic and efficient way, providing value for our customers. The *NOA 2016/17*, using the assessment results from *ETYS 2016*, recommended £83 million of development spend on future network reinforcements in 2017 to provide the required transmission capabilities. Similarly, the results from *ETYS 2017* will feed into *NOA 2017/18*, which we will publish in January 2018.

As our System Operator (SO) role continues to evolve, we're looking to encourage and assess a broader range of solutions to meet transmission needs. This will help improve our investment recommendations for the benefit of our consumers.

I hope that you find this document, along with our other System Operator publications, useful as a catalyst for wider debate. For more information about all our publications, please see page 3.

Please share your views with us; you can find details of how to contact us on our website [www2.nationalgrid.com/UK/Industry-information/Future-of-Energy/Electricity-Ten-Year-Statement/](http://www2.nationalgrid.com/UK/Industry-information/Future-of-Energy/Electricity-Ten-Year-Statement/).

**Julian Leslie**  
Head of Network Capability  
(Electricity)

# Contents

<b>Executive summary</b> .....	<b>03</b>
<b>Key messages</b> .....	<b>05</b>

## Chapter one

<b>Introduction</b> .....	<b>08</b>
1.1 <i>ETYS and the NOA</i> .....	09
1.2 <i>ETYS-NOA and TYNDP</i> .....	10
1.3 <i>ETYS and the System Operability Framework</i> .....	11
1.4 <i>Improving your experience</i> .....	12

## Chapter two

<b>Network development inputs</b> .....	<b>14</b>
2.1 <i>Future energy scenarios</i> .....	15
2.2 <i>Applying the future energy scenarios in system planning</i> .....	17
2.3 <i>Interconnector information</i> .....	20

## Chapter three

<b>The electricity transmission network</b> .....	<b>24</b>
3.1 <i>Introduction</i> .....	24
3.2 <i>NETS background</i> .....	25
3.3 <i>NETS boundaries</i> .....	26
3.4 <i>Network capability and requirements by region – Scottish boundaries</i> .....	31
3.5 <i>Network capability and requirements by region – The North of England boundaries</i> .....	54
3.6 <i>Network capability and requirements by region – Wales and the Midlands boundaries</i> .....	65
3.7 <i>Network capability and requirements by region – Eastern boundaries</i> .....	77
3.8 <i>Network capability and requirements by region – South of England boundaries</i> .....	82

## Chapter four

<b>The way forward</b> .....	<b>96</b>
4.1 <i>The ETYS 2017 and NOA 2017/18 under the ITPR arrangement</i> .....	96
4.2 <i>The FSO programme and the ETYS</i> .....	97
4.3 <i>Stakeholder feedback</i> .....	98

## Chapter five

<b>Appendix overview</b> .....	<b>100</b>
<b>Meet the ETYS team</b> .....	<b>102</b>
<b>Glossary</b> .....	<b>104</b>
<b>Disclaimer</b> .....	<b>109</b>

# Executive summary

---

## As GB System Operator, National Grid is ideally placed to stimulate discussion and highlight potential issues and opportunities for energy delivery across GB.

With an unprecedented capacity of renewable generation now connected and more on the way, including interconnectors, the power transmission networks have been adapting accordingly, so they remain fit for purpose and the lights stay on. This year has also seen the closure of several traditional coal and gas power stations, an expected change but one that highlights the approaching end of an era of domination by large-scale combustion-based generation.

To show you our view of what can be expected of the electricity industry in the near future, we have developed a suite of publications. The starting point for this suite is the *Future Energy Scenarios (FES)*. The *FES* is published annually, and takes input from our stakeholders from across the energy industry to help form a set of credible scenarios.

These scenarios are based on the energy trilemma (security of supply, sustainability and affordability) and provide supply and demand projections out to 2050. We use these scenarios to inform the network analysis and the investment we are planning, which will benefit our customers.

For short-term challenges around gas and electricity transmission, we produce the *Summer Outlook* and *Winter Outlook* reports every six months. They are published ahead of each season to provide a view of the gas and electricity supply and demand for the coming summer or winter. These publications are designed to support and inform business planning activities and are complemented by summer and winter consultations and reports.

For our long-term view of the electricity and gas transmission capability and operability, we publish the *Ten Year Statements (ETYS and GTYS)*, electricity *Network Options Assessment (NOA)*, *Gas Future Operability Planning (GFOP)* and electricity *System Operability Framework (SOF)*.

The *Gas Ten Year Statement (GTYS)* describes in detail what and where entry and exit capacity is available on the gas National Transmission System (NTS). The *GTYS* provides an update on projects we are currently working on. It also provides our view of the capability requirements and network development decisions that will be required for the NTS over the next ten years.

The *Electricity Ten Year Statement (ETYS)* applies the future energy scenarios to network models and highlights the capacity shortfalls and availability on the GB National Electricity Transmission System (NETS) over the next ten years. If you are interested in finding out about the network investment recommendations that we believe will meet these requirements across the GB electricity transmission network, please consider reading the *Network Options Assessment (NOA)*.

The *Network Options Assessment (NOA)* builds upon the future capacity requirements described in *ETYS*. Taking into account reinforcements presented by the transmission owners in Great Britain, it presents an assessment of network development options and recommends what we believe will provide best value to satisfy the requirements of the GB electricity transmission network.

## Executive summary

---

Our *Gas Future Operability Planning (GFOP)* publication describes how changing requirements affect the future capability of the NTS beyond 2050. It also considers how these requirements may affect NTS operation and our processes. This, in turn, may lead us to modify our operational processes and decision making. This publication helps to make sure we continue to maintain a resilient, safe and secure NTS into the future.

The *System Operability Framework (SOF)* uses the future energy scenarios to examine future requirements for the operability of GB electricity networks. It describes developments in operational needs and provides information that can help towards developing new technology, codes and solutions that both maintain and improve system operability.

# Key messages

---

## We have assessed the capability of the National Electricity Transmission System (NETS) against the requirements derived from the future energy scenarios, using boundary analysis techniques.

---

**Below is a summary of the main findings, together with how these findings will be used in the NOA and the future development of the ETYS.**

1. When commissioned, the Western HVDC will significantly increase the capacity of our network. However in the years to come, the NETS will potentially face capacity deficits in a number of regions due to the following factors:
  - Increasing quantities of wind generation connected across the Scottish networks will double north-to-south transfer requirements within ten years from Scotland to England.
  - We have also found that at times of low wind output, more network capacity could be required to meet the south-to-north transfer requirements for demand in the north of England and Scotland.
  - Large growth of around 5GW in low carbon generation and interconnectors in the north of England, combined with increased Scottish generation, will increase export requirements into the English Midlands.
  - High growth in the next decade of up to 10GW in generation coming from offshore wind on the east coast connecting to East Anglia. Transfer of power from this region to the south of England will risk stressing this region of the network.
  - New interconnections coming in will potentially place increased stress on the southern English network when these interconnectors export power out of Great Britain.
2. The NOA process will evaluate options for NETS development and condense them to a set of SO preferred options and investment recommendations. These results will be shown in the *NOA 2017/18* report to be published in January 2018.
  - For *NOA 2017/18*, we expect to assess around eighty NETS reinforcement options. Following our cost benefit analysis we will identify the options requiring expenditure in 2018, as well as those worth delaying.
3. Ofgem has published its decision for the legal separation of the Electricity System Operator within the National Grid Group. This marks a significant milestone in our UK market focus on future networks. This will shape the future development of the *ETYS* and *NOA* publications – as part of moves to improve investment recommendations for the benefit of our customers and consumers. Consequently, we will be looking to encourage and assess a growing and diverse range of solutions to meet transmission needs. We are also developing new tools with help and feedback from the industry to support our planning studies. Following these developments, we will determine how to best use the *ETYS* and the *NOA* report as a way to facilitate communication to stakeholders about the future development, opportunities and challenges in the NETS.
4. We know the NETS will see more impact from new technologies such as electric vehicles, battery storage and heat pumps. As a result, the requirements of NETS will become increasingly complex. We are taking this evolution in requirements into account and are developing analysis tools to assess this future transition.





# Chapter one

---

Introduction

08

---

# Introduction

---

*The Electricity Ten Year Statement (ETYS) presents the National Grid System Operator (SO) view of future transmission requirements and the capability of the Great Britain (GB) National Electricity Transmission System (NETS). This is a significant part of our annual network planning process. Through it, we identify requirements that may lead to network development. The options for network development are subsequently assessed through the Network Options Assessment (NOA) process.*

This is our sixth *ETYS*, which we produce in our role as the System Operator (SO), with assistance from the Transmission Owners (TOs) in Scotland (SHE Transmission and SP Transmission), and in England and Wales (National Grid Electricity Transmission Owner).

The aim of this document is to provide you an overview of the NETS, an expression of its power transfer capability and its potential future capability requirements.

Since the first *ETYS* published in 2012 and the Seven Year Statement that preceded it, what we publish as National Grid System Operator has changed and developed. We welcome any stakeholder feedback on

what we publish, and aim to use that feedback to further improve our publications. If you would like to send us any feedback or have suggestions, you can find details of how to contact us at the end of this document.

The first *ETYS*, published in 2012, covered everything from scenarios, system requirements, development plans and technical issues in one document. This became too large and unwieldy and further the SO took on new responsibilities under Integrated Transmission Planning and Regulation (ITPR)<sup>1</sup> so now the single large document has been split into separate ones that focus on specific areas, which we describe below.

---

<sup>1</sup> <https://www.ofgem.gov.uk/electricity/transmission-networks/integrated-transmission-planning-and-regulation>

## 1.1 ETYS and the NOA

Part of the SO role is to assess and make appropriate recommendations about reinforcing the NETS. This is so we can meet our customers' requirements in an economic and efficient way. We do this in three stages. The first stage starts with establishing the future energy scenarios. The second stage is determining the NETS's requirements, which we describe in *ETYS*. And finally, we evaluate network development options, and publish investment recommendations within the *NOA* report.

The *ETYS* complements the *NOA* report, because information about NETS capability and future requirements described in the *ETYS* feed into the analysis required to produce the *NOA* report. This relationship makes sure the *NOA* report recommends the development of projects at the right time, which assists TOs for the long-term planning of the NETS.

In January this year, the *NOA 2016/17* recommended options to develop the NETS based on *ETYS 2016*. This included a recommended investment of £83 million for NETS development projects that have a total value of £3.8 billion over their lifetime. It further recommended delaying projects which may have committed £2.5 million of spend in 2017 according to our scenario-based 'single year least regret' analysis. The *NOA 2017/18* report, due in January 2018, will use this year's *ETYS* findings in order to present updated recommendations.

The *NOA* also considers arrangements for the development of cross-border (including interconnections with mainland Europe) electricity transmission networks. So, we need to consider the relationship between the *ETYS-NOA* and European transmission developments described in the *Ten Year Network Development Plan (TYNDP)*. The *TYNDP* is produced by the European Network of Transmission System Operators for Electricity (ENTSO-E).

# Introduction

---

## 1.2 *ETYS-NOA* and *TYNDP*

The *TYNDP* is similar to the *ETYS* and *NOA* but it extends to cover all the European Transmission System Operators (TSOs). It is published every two years with TSO participation in accordance with Regulation (EC) 714/2009. The next publication is due in December 2018.

Although *TYNDP*, *ETYS* and *NOA* all highlight future network developments, there are important differences that separate them. Firstly, the *TYNDP* is produced every two years, whereas the *ETYS* and *NOA* are produced annually. Therefore what can be seen in the *TYNDP* usually lags the *ETYS* and *NOA*.

A different set of energy visions are used for the *TYNDP* compared to the future energy scenarios used for *ETYS* and *NOA*.

The *TYNDP* primarily focuses on pan-European projects that satisfy European Union objectives, such as facilitation of cross-border trade and European environmental targets.

The analysis for the *TYNDP* is conducted by European regional groups, of which GB participates in the North Seas regional group.

You can find more information about the *TYNDP* at <http://tyndp.entsoe.eu/>

---

## 1.3 ETYS and the System Operability Framework

In 2015, we produced the *System Operability Framework*<sup>2</sup> (SOF) for the first time as a standalone document. Previously, it had been published as part of the ETYS. This move to a separate document has allowed the SOF the flexibility to provide a more focused and detailed long-term view about the operability of the GB NETS.

Power systems are designed to be both operable and capable to transmit power from suppliers to consumers. The operability of power systems is a function of generator, demand and NETS characteristics. The SOF

considers this complex function in determining how operable the power system will be in light of the changing mix and distribution of generation technologies across the NETS. So, while the SOF focuses on evaluating the operability of the NETS, the ETYS evaluates the NETS's capability to transmit power.

As a common point, however, both the ETYS and the SOF rely on the *Future Energy Scenarios (FES)* to develop credible generation and demand backgrounds. These are used to influence their respective analyses.

---

<sup>2</sup> [www2.nationalgrid.com/UK/Industry-information/Future-of-Energy/System-Operability-Framework/](http://www2.nationalgrid.com/UK/Industry-information/Future-of-Energy/System-Operability-Framework/)

# Introduction

---

## 1.4 Improving your experience

---

We hope you will benefit from the 2017 *ETYS* and its sister publications, the *NOA*, *FES* and *SOF*.

We have updated our National Grid website – and the links to the *ETYS* web page have changed. To access the site please click on the following link: <https://www.nationalgrid.com/uk/publications/electricity-ten-year-statement-etys>. We'd also like to encourage you to bookmark it for future use.

We are keen to hear your views as we continue developing the *ETYS*. This year, we were able to gather feedback face-to-face at our electricity customer seminars, as well as from correspondence sent to our *ETYS* email address.

Some of your feedback told us that you'd like to see detailed information in relation to both local network flows and future generation (including energy storage) statuses than what we previously published in the main *ETYS* document. Having considered this, but being limited by the need to maintain customer confidentiality, we unfortunately cannot publish more specific information than we did last year. However, we have added more information to the appendices, compared with last year. We've included power flow diagrams to represent more scenarios than last year. We've also provided detailed demand level information. This includes reactive gains and embedded generation, as well as storage and indicative demand side response. We've further provided transmission level information on national energy storage and interconnector developments. You can find all this information in Appendix E. You'll find further details of this in the appendix section of this document. Furthermore, we hope you can supplement this information with that from the *Future Energy Scenarios (FES)* charts workbook published here (<http://fes.nationalgrid.com/fes-document/fes-2017/>)

# Chapter two

---

Network development inputs

14

---

# Network development inputs

---

**To identify the future transmission requirements of the National Electricity Transmission System (NETS) we must first understand what power demand and generation may be connected to the network. We do this by using the future energy scenarios. Then, by applying planning standards, we can identify future system needs.**

Assisted by engaging with our customers and stakeholders, we are able to produce a set of credible future energy scenarios, which can be used for network planning.

In addition to the statutory data submissions, we have tried to make our stakeholder engagement as accessible as possible through a number of means, including workshops, webinars and bilateral meetings. We then analyse the feedback we receive, and use it to influence the development of our scenarios.



## 2.1 Future energy scenarios

Our 2017 future energy scenarios are **Two Degrees**, **Slow Progression**, **Steady State** and **Consumer Power**. Again, they are an evolution from previous years and have taken into consideration valuable feedback from our customers and stakeholders, as well as our own analysis. Figure 2.1 provides a brief overview of each of the scenarios and their relative position on the 2x2 matrix. You can find more information about the 2017 *Future Energy Scenarios* on our website<sup>1</sup>.

We have continued to use our 2x2 matrix with the axes Prosperity and Green Ambition: Prosperity means the amount of money available in the economy for government expenditure, for businesses to invest, and for consumers to spend.

Green Ambition reflects the level at which society and policies engage with becoming environmentally friendly to help reduce our carbon emissions and increase sustainability.

**Figure 2.1**  
The 2017 scenario matrix

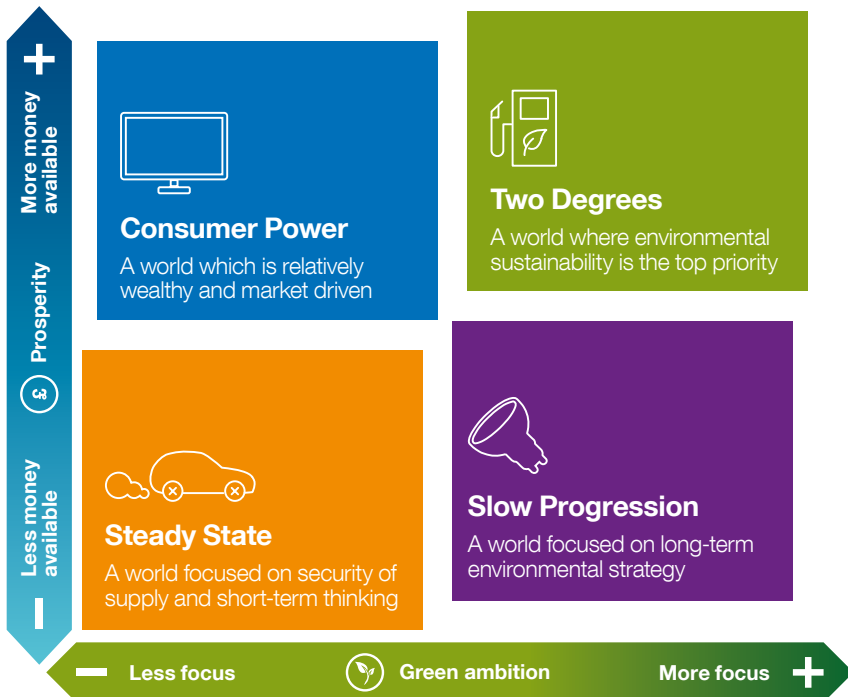

<sup>1</sup> <http://fes.nationalgrid.com/>

# Network development inputs

---

This year, the relative positioning of the scenarios on the axes has changed. This reflects a wider range of economic forecasts used to reflect the uncertainty around the

impact of the UK leaving the European Union (EU). It also shows greater differences in levels of green ambition.

---

## 2.1.1 New scenario names

The 2016 scenario names **Gone Green** and **No Progression** have been retired:

**Gone Green** has substantially changed since we first launched the *FES* in 2011. It has been renamed **Two Degrees** to reflect its focus on all forms of low carbon energy, rather than solely renewables. The name reflects the ambition of restricting a global temperature rise to below two degrees Celsius, above pre-industrial levels, as set out in the Paris Agreement<sup>2</sup>.

**No Progression** has been renamed **Steady State** as our customers and stakeholders comments suggested that **No Progression** implied no movement. **Steady State** represents a world where current levels of progress and innovation continue.

---

<sup>2</sup>[http://unfccc.int/paris\\_agreement/items/9485.php](http://unfccc.int/paris_agreement/items/9485.php)

---

## 2.2 Applying the future energy scenarios in system planning

The future energy scenario data is applied to network simulation models of the NETS so that we can analyse their impact on the network and assess the network's performance.

---

### 2.2.1 Application of demand data

The future energy scenario demand backgrounds provide us with national demand, broken down into regions. This is further split down to individual supply points, so the flow of power from supply to demand

can be monitored. Embedded generation is taken into account in the demand applied to the models, so that both transmission and embedded connected generation is considered consistently.

---

### 2.2.2 Application of generation data

The NETS Security and Quality of Supply Standard (SQSS)<sup>3</sup> outlines the two criteria (security and economy) that form the main interconnected transmission system (MITS)<sup>4</sup> capability planning requirements. These criteria define two different generation and demand

backgrounds against which we can monitor the flow of power from supply to demand. You can find more detail about this monitoring in Chapter 3. Here we focus on how the generation data is applied to meet national average cold spell (ACS) peak demand.

---

#### 2.2.2a Security criterion

The security criterion assumes that intermittent generation and interconnectors are unavailable, and power must come from generation plant with reliable energy supply.

This scenario is to assess whether the NETS is sufficient to supply demand at times when intermittent low-carbon generation and interconnectors are unavailable.

---

<sup>3</sup> [www2.nationalgrid.com/uk/industry-information/electricity-codes/sqss/the-sqss/](http://www2.nationalgrid.com/uk/industry-information/electricity-codes/sqss/the-sqss/)

<sup>4</sup> MITS is the wording used in the SQSS to refer to the NETS. In the ETYS therefore, the words MITS and NETS are interchangeable.

## Network development inputs

To set up the security generation scenario, we start by checking if we need to trim the total generation connected to the NETS to below 120% of the total ACS demand, in accordance with the SQSS. We trim the total generation capacity to 120% by applying a ranking order to help identify the generation units that are most likely to operate and meet 100% ACS peak demand, and those which are most likely to provide 20% reserve.

We apply the ranking order considering both future and existing generation.

For existing generation, we apply appropriate ranks, by looking at how the unit operated during the previous two winter periods (beginning of December to the end of January). The method described for ordering plant in terms of operational history is supported by our experiential judgement

and market intelligence. For example, a plant may have achieved a low ranking based on the previous winter's operational data, but it could be that this was down to a unique set of circumstances that are unlikely to be repeated in the future (for example, a plant that has been mothballed but market intelligence suggests it may return in the future). So plant rankings may be revised accordingly.

For future plant, we apply appropriate ranks by considering the fuel type of the unit. We assume that low-carbon plant is more likely to operate as baseload, and that new thermal plant is likely to be more efficient than existing thermal generation so we give it a higher ranking.

The ranking order we use to determine the operation of future plant is shown in Table 2.1.

**Table 2.1**  
*Ranking order*

Rank	Fuel type
1	Hydro tranche 1
2	Nuclear (new)
3	Hydro tranche 2
4	Hydro tranche 3
5	Nuclear (existing)
6	CCS
7	Biomass
8	Gas thermal (new)
9	Storage (new)
10	Existing plant per operation calculation and hydro tranche 4 and existing pumped storage
11	Gas turbines

## 2.2.2b Economy criterion

The economy criterion assumes a credible dispatch with a significant output from intermittent generation, such as wind farms and support from interconnectors. This tests if the NETS has suitable capacity without unduly restricting generation output.

To set up the dispatch scenario which represents the economy criterion, we use three categories for generation units:

non-contributory, directly scaled and variably scaled. Non-contributory plants, like open cycle gas turbines (OCGTs), are not included in the dispatched generation background. Directly scaled plants, like wind and nuclear, are included in the dispatch scenario using the scaled dispatch factors, as specified by the SQSS (and shown in table 2.2 below). Finally we use variably scaled plants to maintain the balance of demand and generation.

**Table 2.2**  
*List of directly scaled plants and the associated scaling factors*

Fuel type	Scaling factor
Interconnectors importing to GB	100%
Nuclear	85%
Coal-fired stations fitted with CCS	85%
Gas-fired stations fitted with CCS	85%
Wind	70%
Tidal/wave	70%
Pumped storage	50%

These two criteria allow us to assess the capability requirement of the MITS in order to maintain both security of supply and facilitate the economic and efficient operation of the

generation market. Chapter 3 explains how we use these two criteria to determine network capability and regional requirements.

# Network development inputs

## 2.3 Interconnector information

As new interconnectors to neighbouring countries are being built, they are forming an increasing part of the GB energy portfolio. With the ability to both bring power into Britain and export it out, they can have a large influence on power flows across the NETS. Therefore, they play an important part of future NETS planning.

### Current and planned interconnection

You can find the most up-to-date details of transmission contracted interconnectors from the interconnector Transmission Entry Capacity (TEC) Register page: [www2.nationalgrid.com/UK/Services/Electricity-connections/Industry-products/TEC-Register/](http://www2.nationalgrid.com/UK/Services/Electricity-connections/Industry-products/TEC-Register/)

Further projects have applied for projects of common interest (PCI) status under the EU's Trans-European Networks (Energy) (TEN-E) regulations. Other projects are already in the public domain, such as in the *Ten-Year Network Development Plan (TYNDP)*. These are set out in Table 2.3 below.<sup>5</sup>

Similar to our approach to the transmission generation backgrounds, we have made assumptions about the connection of interconnectors in the *FES*. Again, like the generators, we have used a full range of factors, including planning consent, contractual connect dates, environment legislation and up-to-date market intelligence in making these assumptions.

**Table 2.3**  
*Interconnectors*

Name	Owner(s)	Connects to	Capacity	Key Dates
<b>Operational Interconnectors</b>				
IFA	NGIL and RTE	France	2,000 MW	Operational since 1986
Moyle	NI Energy Holdings	Northern Ireland	450 MW to NI (295 MW to GB)	Operational since 2002
BritNed	NG and TenneT	The Netherlands	1,200 MW	Operational since 2011
EWIC	Eirgrid	Republic of Ireland	505 MW	Operational since 2012
Isle of Man Interconnector	Manx Electricity Authority	Isle of Man	74 MW	Operational since 2000
<b>Contracted Interconnectors</b>				
Nemo	NGIL and Elia	Belgium	1,000 MW	Contracted 2018
NSN	NGIL and Statnett	Norway	1,400 MW	Contracted 2019
IFA 2	NGIL and RTE	France	1,000 MW	Contracted 2019
ElecLink	ElecLink Ltd	France	1,000 MW	Contracted 2020
FABLink	FabLink Ltd	France	1,400 MW	Contracted 2020
Aquind	Aquind Ltd	France	2,000 MW	Contracted 2020

<sup>5</sup>[http://ec.europa.eu/energy/infrastructure/pci/doc/2013\\_pci\\_projects\\_country.pdf](http://ec.europa.eu/energy/infrastructure/pci/doc/2013_pci_projects_country.pdf)

Name	Owner(s)	Connects to	Capacity	Key Dates
Viking Link	NGI Holdings	Denmark	1,000 MW	Contracted 2022
Northconnect	Agder Energi, E-CO, Lyse, & Vattenfall AB	Norway	1,400 MW	Contracted 2021
Greenage Power Interconnector	Greenage Power Ltd	Germany	1,400 MW	Contracted 2022
Greenlink	Greenwire Transmission Pembroke Ltd	Republic of Ireland	500 MW	Contracted 2022
Gridlink Interconnector	Gridlink Interconnector Ltd	France	1,500 MW	Contracted 2022

**Projects of Common Interest or TYNDP Projects (applied for PCI status or pre-feasibility studies announced)**

Name	2016 TYNDP Project Reference	PCI Ref	Capacity	Connects to
Nemo	74	1.1.1	1,000 MW	Belgium
Belgium-GB-2	121	1.1.2	1,000 MW	Belgium
IFA 2	25	1.7.2	1,000 MW	France
FABLink	153	1.7.1	1,400 MW	France
ElecLink	1005	1.7.3	1,000 MW	France
IceLink	214	1.13	1,000 MW	Ireland
Greenwire	185	1.9.1	3,000 MW	Ireland
Codling Park	None	1.9.2 and 1.9.3	500–1,000 MW	Ireland
Energy Bridge	None	1.9.4, 1.9.5 and 1.9.6	5,000 MW	Ireland
Irish-Scottish Isles	189	2.13.1 and 2.13.2	1,200 MW	Northern Ireland
NSN	110	1.10	1,400 MW	Norway
North Connect	190	1.10	1,400 MW	Norway
Viking Link	167	1.14	1,000 MW	Denmark
New GB-Belgium Belgium – UK	121	None	1,000 MW	Belgium
New GB-France Interconnector	None	None	1,000 MW	France
New GB- Neth Interconnector	None	None	1,000 MW	The Netherlands
Aquind	274	1.7.4	2,000 MW	France





# Chapter three

---

The electricity transmission network

24

---

# The electricity transmission network

## 3.1 Introduction

**The GB National Electricity Transmission System (NETS) must continue to adapt and be developed so power can be transported from source to demand, reliably and efficiently. To make sure this happens, we must understand its capabilities and the future requirements that may be placed upon it.**

When we assess future requirements, we need to bear in mind that we have a large number of signed contracts for new generation to connect to the NETS. In addition, the development of interconnectors connecting Great Britain to the rest of the Europe will have a big impact on future transmission requirements.

In our experience, it is unlikely that all customers will connect exactly as contracted today. We cannot know exactly how much and when generation will close and new generation will connect, so we use our future energy scenarios to help us decide on credible ranges of future NETS requirements and its present capability.

This is done using the system boundary concept. It helps us to calculate the NETS's boundary capabilities and the future transmission requirements of bulk power transfer capability. The transmission system is split by boundaries<sup>1</sup> that cross important power-flow paths where there are limitations to capability or where we expect additional bulk power transfer capability will be needed. We apply the SQSS<sup>2</sup> to work out the NETS boundary requirements.

In this chapter we describe the NETS characteristics. We also discuss each of the NETS boundaries, grouped together as regions, to help you gain an overview of the total requirements, both regionally and by boundary.

In this chapter we will provide analysis to show you how, and when in the years to come, the NETS will potentially face network capacity deficits on a number of its boundary regions. These deficits will predominantly be faced in the future. We will show you that presently the majority of NETS boundaries have sufficient capability margins to transfer power from where it is generated to where it is demanded.

The results presented in this chapter will be used in the NOA 2017/18 to present an assessment of the SO's preferred reinforcement options, and recommendations to address the potential future NETS boundary capacity deficits.

<sup>1</sup> Please note that these boundaries will be reviewed annually and updated as appropriate.

<sup>2</sup> [www2.nationalgrid.com/UK/Industry-information/Electricity-codes/System-Security-and-Quality-of-Supply-Standards/](http://www2.nationalgrid.com/UK/Industry-information/Electricity-codes/System-Security-and-Quality-of-Supply-Standards/)

---

## 3.2 NETS background

**The NETS is mainly made up of 400kV, 275kV and 132kV assets connecting separately owned generators, interconnectors, large demands and distribution systems. As the SO, we are responsible for managing the system operation of the transmission networks in England, Wales, Scotland and offshore.**

The 'transmission' classification applies to assets at 132kV or above in Scotland or offshore. In England and Wales, it relates to assets at 275kV and above.

National Grid Electricity Transmission owns the transmission network in England and Wales. The transmission network in Scotland is owned by two separate transmission companies: SHE Transmission in the north

of Scotland and SP Transmission in the south of Scotland. The offshore transmission systems are also separately owned. Fourteen licensed offshore transmission owners (OFTOs)<sup>3</sup> have been appointed through the transitional tendering process. They connect operational offshore wind farms that were given Crown Estate seabed leases in allocation rounds 1, 2 and 3.

---

<sup>3</sup> [www.ofgem.gov.uk/system/files/docs/2016/09/electricity\\_registered\\_or\\_service\\_addresses\\_new\\_0.pdf](http://www.ofgem.gov.uk/system/files/docs/2016/09/electricity_registered_or_service_addresses_new_0.pdf)

# The electricity transmission network

---

## 3.3 NETS boundaries

**To provide an overview of existing and future transmission requirements, and report the restrictions we will see on the NETS, we use the concept of boundaries. A boundary splits the system into two parts, crossing critical circuit paths that carry power between the areas where power flow limitations may be encountered.**

The transmission network is designed to make sure there is enough transmission capacity to send power from areas of generation to areas of demand.

Limiting factors on transmission capacity include thermal circuit rating, voltage constraints and/or dynamic stability. From the network assessment, the lowest known limitation is used to determine the network boundary capability. The base capability of each boundary in this document refers to the capability expected for winter 2017.

Defining the NETS boundaries has taken many years of operation and planning experience of the transmission system. The NETS boundaries have developed around major sources of generation, significant route corridors and major demand centres. A number of recognised boundaries are regularly reported for consistency and comparison purposes. When significant transmission system changes occur, new boundaries may be defined and some existing boundaries either removed or amended (an explanation will be given for any changes).

---

### 3.3.1 GB NETS boundary map

Figure 3.1 shows all the boundaries we have considered for our ETYS analysis. Over the years, we have continuously developed the transmission network to ensure there is sufficient transmission capacity to effectively transport power across the country. As a result of network development, some

boundaries are now not reported as they have become redundant. In our boundary capability results section, we highlight only the boundaries that are more likely to require further future development to satisfy future NETS requirements.

**Figure 3.1**  
*GB NETS boundaries*

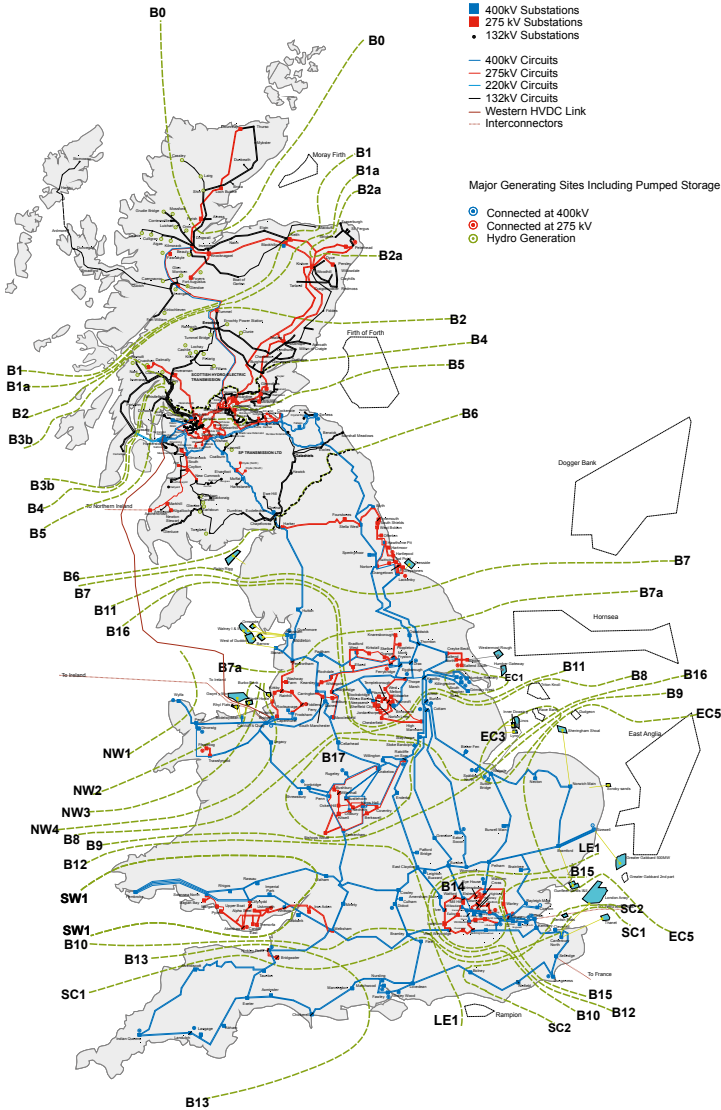

# The electricity transmission network

To help describe related issues, we have grouped the boundaries into five regions

(the Scotland region is counted as one), as shown in Figure 3.2.

**Figure 3.2**  
Regional map

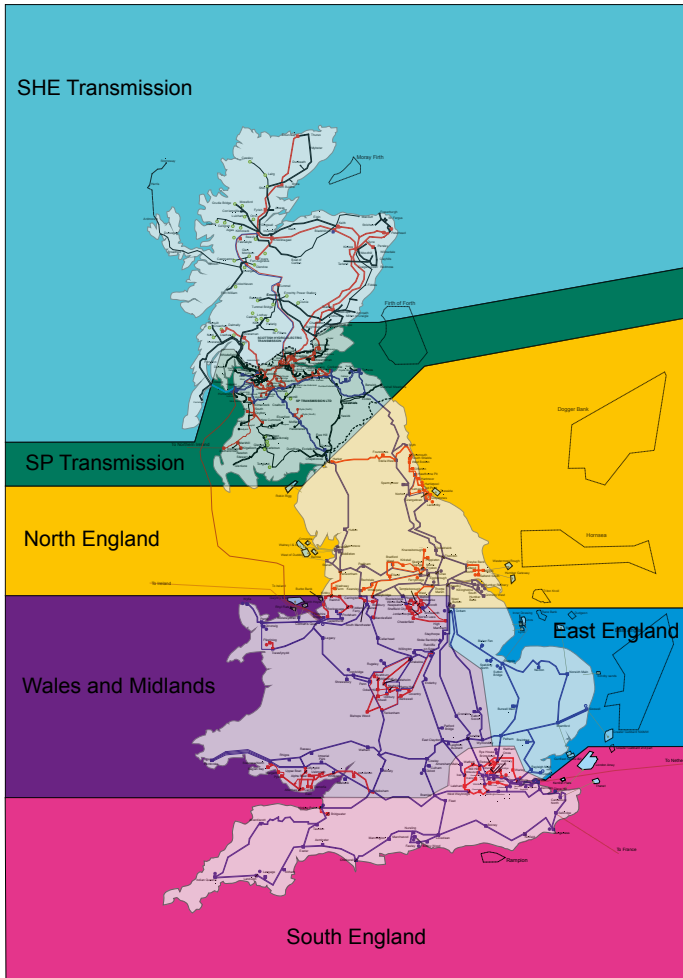

### 3.3.2 Determining the present capability and future requirements of the NETS boundaries

The boundaries used by *ETYS* and *NOA* can be split into two different types:

**Local boundaries** – are those which encompass small areas of the NETS with high concentration of generation. These small power export areas can give high probability of stressing the local transmission network due to coincidental generation operation.

**Wider boundaries** – are those that split the NETS into large areas containing significant amounts of both generation and demand. The SQSS boundary scaling methodologies are used to assess the network capability of the wider boundaries. These methodologies take into account both the geographical and technological effects of generation. This allows for a fair and consistent capability and requirements assessment of the NETS.

- **The security criterion** – evaluates the NETS's boundary transfer requirements to satisfy demand without reliance on intermittent generators or imports from interconnectors. The relevant methodology for determining the security needs and capability are from the SQSS Appendices C and D.
- **The economy criterion** – defines the NETS's boundary transfer requirements when demand is met with high output from intermittent and low-carbon generators and imports from interconnectors. This is to ensure that transmission capacity is adequate to transmit power from the highly variable generation types without undue constraint. The relevant methodology for determining the economy needs and capability are from the SQSS Appendices E and F.

#### Interpreting the boundary graphs

When presenting the boundary required transfers and capability results, it is not practical to show everything at once. This is because there would be extensive overlapping of results and far more information than could be displayed clearly. So, we have simplified the boundary graphs using the style shown in Figure 3.3. In this figure, the coloured plot lines show the future transfer requirements from our four future energy scenarios – both from last year and this year. The black horizontal line represents the present capability in MW of a given boundary, as shown in the y-axis. On the x-axis, the year refers to the winter peak of that year. For example, 2017 represents December 2017 – February 2018.

For most boundaries in which both the security and economy criteria have a boundary required transfer in the same direction, a single graph is shown with one requirement line for each future energy scenario. Each point in each single scenario line is the largest magnitude value of both the economy and security criteria.

For boundaries in which the economy and security criteria can produce boundary flows in different directions, two separate graphs are shown. This mostly applies to the North of England and Scottish boundaries.

# The electricity transmission network

**Figure 3.3**  
*Example of required transfer and base capability for a boundary*

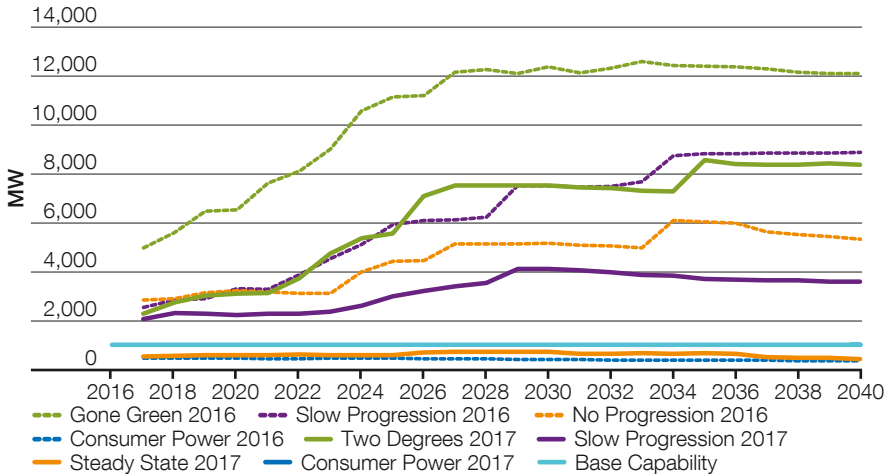

### Stakeholder engagement

If you have feedback on any of the content of this document please send it to [transmission.etyts@nationalgrid.com](mailto:transmission.etyts@nationalgrid.com), catch up with us at one of our consultation events or visit us at National Grid House, Warwick.



## 3.4 Network capability and requirements by region

### Scottish boundaries

#### Introduction

The following section describes the Scottish transmission networks up to the transmission ownership boundary with the England and Wales transmission network. The onshore transmission network in Scotland is owned by SHE Transmission and SP Transmission but is operated by National Grid as System Operator (SO). The Scottish NETS is divided into B0, B1, B1a, B2, B2a, B3b, B4, B5 and B6

(the B6 boundary is shared with National Grid TO). The following boundary information has been provided by the two Scottish transmission owners. The figure below shows likely power flow directions in the years to come up to 2027. The arrows in the diagram are meant to illustrate power flow directions, but are not drawn to scale to reflect the magnitude of power flows.

**Figure 3.4**  
*Scottish transmission network*

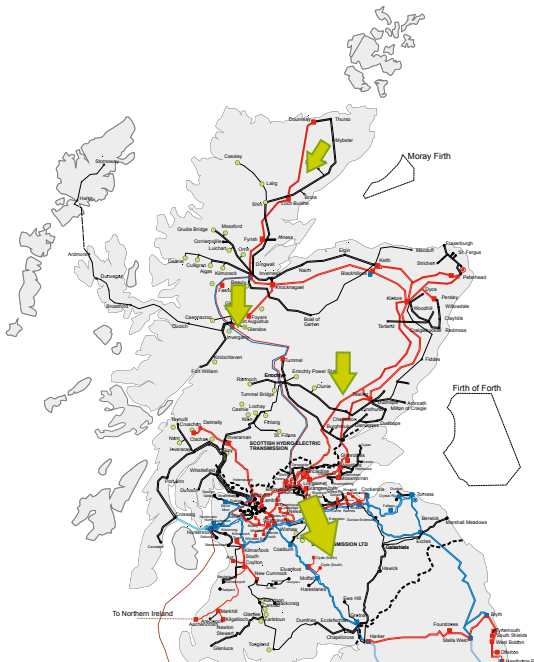

# The electricity transmission network

---

## Primary challenge statement

Scotland is experiencing large growth in renewable generation capacity in remote locations of the network.

## Regional drivers

The rapidly increasing generation capacity, mostly from renewable sources and mainly wind, connecting within Scotland is leading to a shortfall in boundary capacity in some areas. Across all future energy scenarios the fossil fuel generating capacity nearly ceases to contribute to the energy mix, while interconnector and storage capacity

increases. By 2035, the scenarios (shown in Figure SD.1) suggest a total Scottish generating capacity of between 13 and 25 GW. This potentially leads to increasingly dynamic Scottish network behaviour depending on factors such as weather condition and price of electricity. With demand in Scotland not expected to exceed 5.7 GW (shown in Figure SD.2) by 2040, which is much less than the Scottish generation capacity, Scotland will be expected to export power into England. At times of low renewable output, however, Scotland may need to import power from England.

**Figure SD.1**  
Generation mix scenarios for Scotland

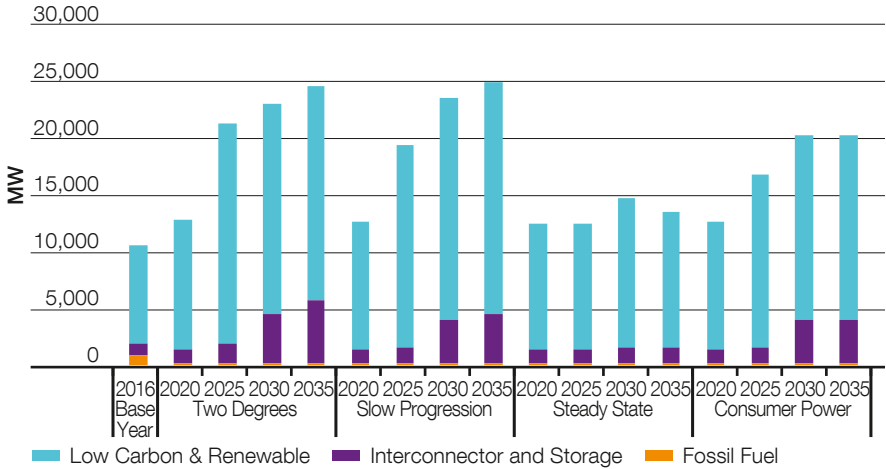

**Figure SD.2**  
Gross demand scenarios for Scotland

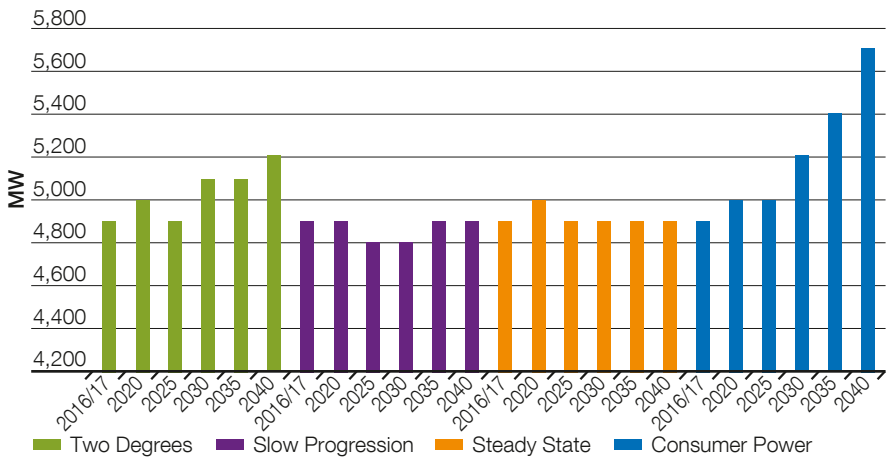

## The electricity transmission network

---

The anticipated increase in renewable generation in Scotland is increasing power transfer across these boundaries. On a local basis, with the anticipated generation development in the north of Scotland there may be limitations on power transfer from generation in the remote Scottish NETS locations to the main transmission routes (B0, B1).

Furthermore, the area around Peterhead is experiencing significant activity with Moray Offshore Windfarm and North Connect interconnector contracted to connect alongside the existing CCGT station. Hence a local boundary assessment is required, to show potential for high generation output and interconnector import and the resulting network limitations (B2a).

The Argyll and the Kintyre peninsula is an area with significant renewable generation activity and low demand. Following completion of the Kintyre–Hunterston project, the Argyll and Kintyre network is no longer radial in nature and will therefore be considered as part of the main Interconnected Transmission System (MITS) as it is now interconnected. The boundary covering this area is B3b. Therefore a local boundary assessment is also needed, to show potential for high generation output and network limitations to power flow (B3b).

As generation within these areas increases over time because of the high volume of new contracted renewable generation seeking connection in the SHE transmission area, boundary transfers across the Scottish NETS boundaries (B1, B1a, B2, B4 and B5 and B6) also increase.

The potential future increase in renewable generation in Scotland is against a backdrop of recent closures or reduced capacity of conventional generation at Longannet, Cockenzie Fife and Peterhead. This represents a 4.7 GW reduction in conventional generation plant in Scotland operating within the wholesale market since 2010. Consequently, from winter 2017/18 both boundaries B5 and B6 have Planned and Required Transfer values with power flows from south to north, when assessed in accordance with the 'Security Background' criteria set out in the SQSS.

While the absolute magnitude of the south to north 'Security' transfers is lower than the north to south 'Economy' transfers, the transmission system requires to be secured for both. The need for network reinforcement to address the above mentioned potential capability issues will be evaluated in the *NOA* 2017/18 cost benefit analysis. Following the evaluation, the preferred reinforcements for the Scotland region will be recommended.

## Boundary B0 – Upper North SHE Transmission

*Figure B0.1*  
Geographic representation of boundary B0

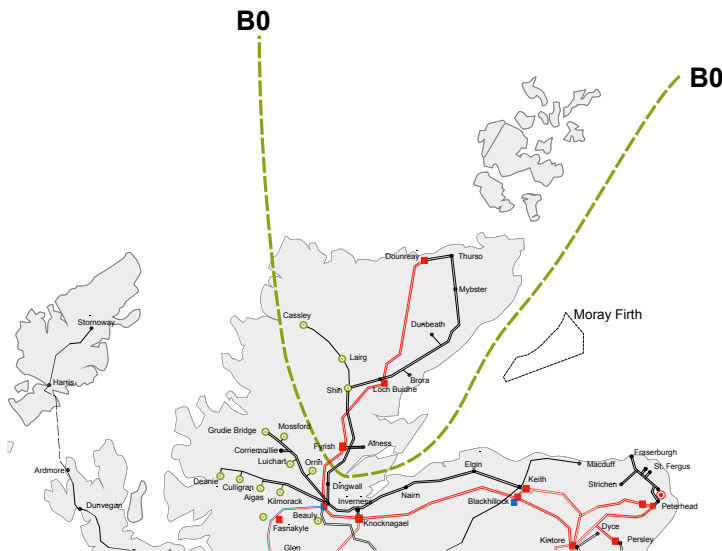

Boundary B0 separates the area north of Beauly, comprising north Highland, Caithness, Sutherland and Orkney. The existing transmission infrastructure north of Beauly is relatively sparse.

The boundary cuts across the existing 275kV double circuit and 132kV double circuits

extending north from Beauly. The 275kV overhead line takes a direct route north from Beauly to Dounreay, while the 132kV overhead line takes a longer route along the east coast and serves the local grid supply points at Alness, Shin, Brora, Mybster and Thurso. The Orkney demand is fed via a 33kV subsea link from Thurso.

# The electricity transmission network

**Figure B0.2**  
Required transfer and base capability for boundary B0

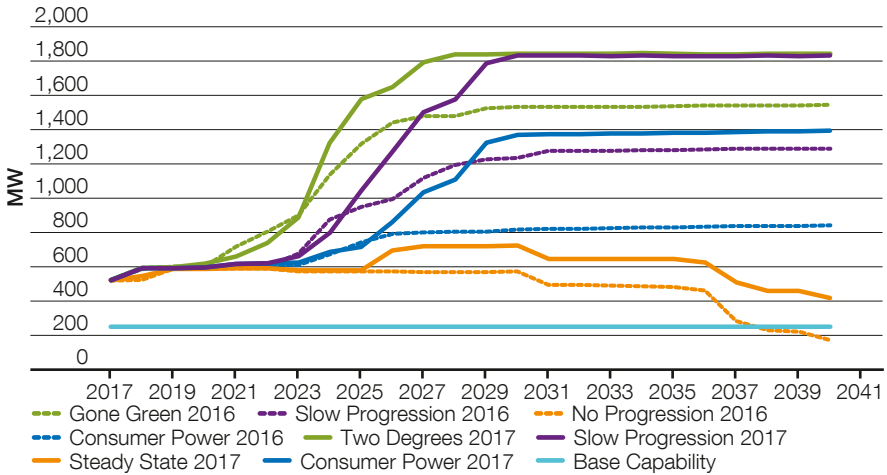

### Boundary requirements and capability

Figure B0.2 above shows the required boundary transfers for B0 from 2017 to 2040. The boundary capability is currently around 0.25 GW.

The power transfer through B0 is increasing due to the substantial growth of renewable generation north of the boundary. This generation is primarily onshore wind, with the prospect of significant marine generation resource in the Pentland Firth and Orkney waters in the longer term.

All scenarios suggest that reinforcement of boundary B0 is required and the Caithness–Moray reinforcement project is presently being implemented to achieve this. This approved project is due for completion in 2018 and comprises an HVDC link between a new substation at Spittal in Caithness and Blackhillock in Moray, along with associated onshore reinforcement works. The onshore works include rebuilding the 132 kV double circuit line between Dounreay and Spittal at 275 kV, a short section of new 132 kV line between Spittal and Mybster, new 275/132 kV substations at Fyrish (near Alness), Loch Buidhe (to the east of Shin), Spittal (5 km north of Mybster) and Thurso.

## Boundary B1 – North West SHE Transmission

*Figure B1.1*  
Geographic representation of boundary B1

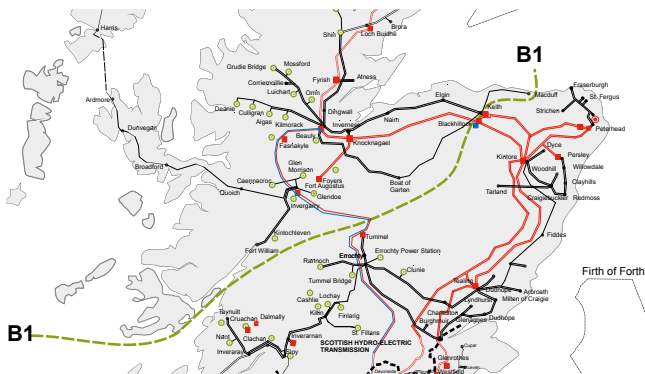

Boundary B1 runs from the Moray coast near Macduff to the west coast near Oban, separating the north-west of Scotland from the southern and eastern regions. The area to the north and west of boundary B1 includes Moray, north Highland, Caithness, Sutherland, Western Isles, Skye, Mull and Orkney. The boundary crosses the 275 kV double circuit running eastwards from Beaulieu, the 275/132 kV interface at Keith and the new Beaulieu to Denny 400 kV and 275 kV double circuit running south from Fort Augustus.

The existing transmission infrastructure in this area comprises mostly 275 kV and 132 kV assets. Two key reinforcement projects have been recently completed to allow for the increasing requirement to export power across boundary B1. The Beaulieu to Denny reinforcement extends from Beaulieu in the north to Denny in the south, providing additional capability for boundary B1 as well as boundaries B1a, B2 and B4. The second project comprised the replacement of conductors on the 275 kV line between Beaulieu, Blackhilllock and Kintore with a higher rated conductor.

# The electricity transmission network

**Figure B1.2**  
Required transfer and base capability for boundary B1

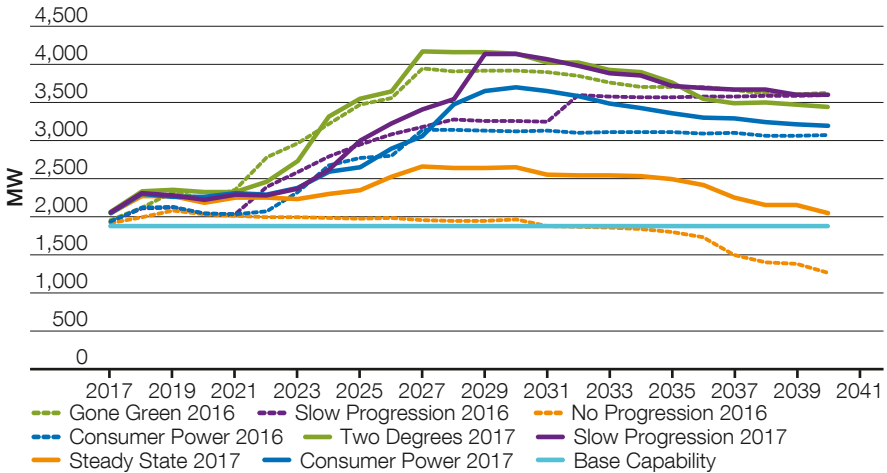

### Boundary requirements and capability

Figure B1.2 above shows the required boundary transfers for B1 from 2017 to 2040. The boundary capability is currently around 1.9GW.

New renewable generation connections north of the boundary are expected to result in a significant massive increase in export requirements across the boundary (see Figure B1.2). All generation north of boundary B0 also lies behind boundary B1.

In all the scenarios there is an increase in the power transfer through B1 due to the large volume of renewable generation connecting to the north of this boundary (see Figure B1.2). Although this is primarily onshore wind and hydro, there is the prospect of significant additional wind, wave and tidal generation resources being connected in the longer term.

Contracted generation behind boundary B1 includes the renewable generation on the Western Isles, Orkney and the Shetland Isles as well as a considerable volume of large and small onshore wind developments. A large new pump storage generator is also planned in the Fort Augustus area. Some marine generation is also expected to connect in this region during the ETYS time period. This is supplemented by existing generation, which comprises around 800MW of hydro and 300MW of pumped storage at Foyers.

The Caithness–Moray HVDC scheme presently under development with expected delivery in 2018 will provide further enhancement to the B1 boundary capability.



## Boundary B1a – North West 1a SHE Transmission

*Figure B1a.1*  
Geographic representation of boundary B1a

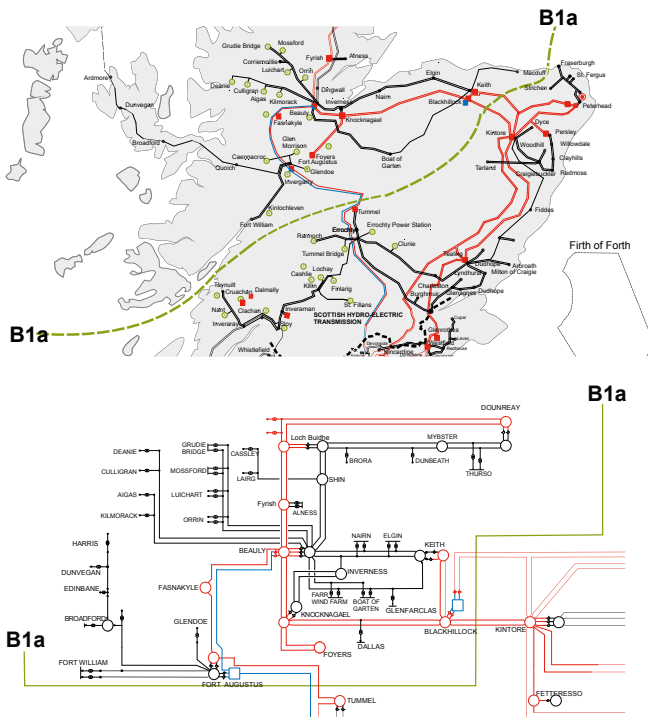

Boundary B1a runs from the Moray coast near Macduff to the west coast near Oban, separating the north-west of Scotland from the southern and eastern regions. The boundary crosses the 275 kV double circuit running eastwards from Blackhillock to Kintore on a direct route and another 275 kV double circuit running eastwards from Keith to Peterhead and Kintore and the 275/400 kV double circuit running south from Fort Augustus. High renewables output causes high transfers

across this boundary. The difference from the existing boundary B1 is that Blackhillock substation is north of the boundary.

A key reinforcement project has been recently completed to allow for the increasing requirement to export power across boundary B1a. The Beauly to Denny reinforcement extends from Beauly in the north to Denny in the south, providing additional capability for boundary B1a as well as boundaries B1, B2 and B4.

# The electricity transmission network

**Figure B1a.2**  
Required transfer and base capability for boundary B1a

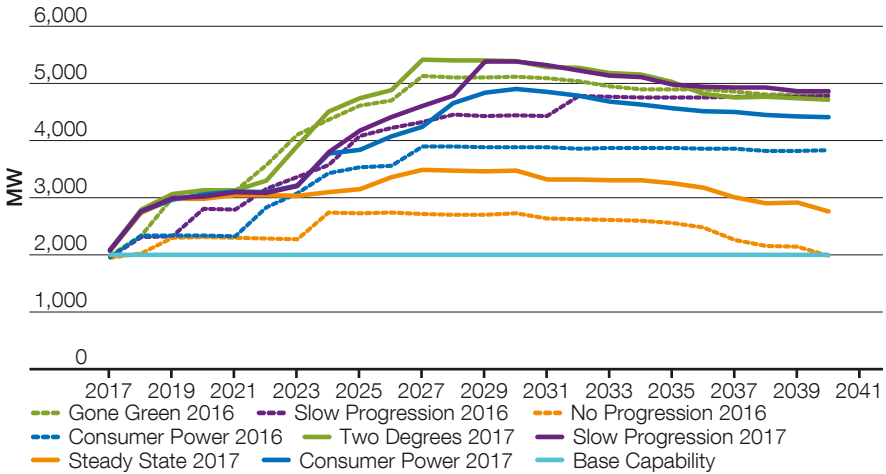

### Boundary requirements and capability

Figure B1a.2 above shows the required boundary transfers for B1a from 2017 to 2040. The boundary capability is currently around 2GW.

New renewable generation connections north of the boundary are expected to result in a significant increase in export requirements across the boundary. All generation north of boundaries B0 and B1 also lies behind boundary B1a.

In all the future energy scenarios there is an increase in the power transfer through B1a due to the large volume of renewable generation connecting to the north of this

boundary. Although this is primarily onshore wind and hydro, there is the prospect of significant additional wind, wave and tidal generation resources being connected in the longer term. Contracted generation behind boundary B1a includes the renewable generation on the Western Isles, Orkney and the Shetland Isles with a considerable volume of large and small onshore wind developments. A large new pump storage generator is also planned in the Fort Augustus area. Some marine generation is also expected to connect in this region during the ETYS time period. This is supplemented by existing generation, which comprises around 800MW of hydro and 300MW of pumped storage at Foyers.

## Boundary B2 – North to South SHE Transmission

*Figure B2.1*  
Geographic representation of boundary B2

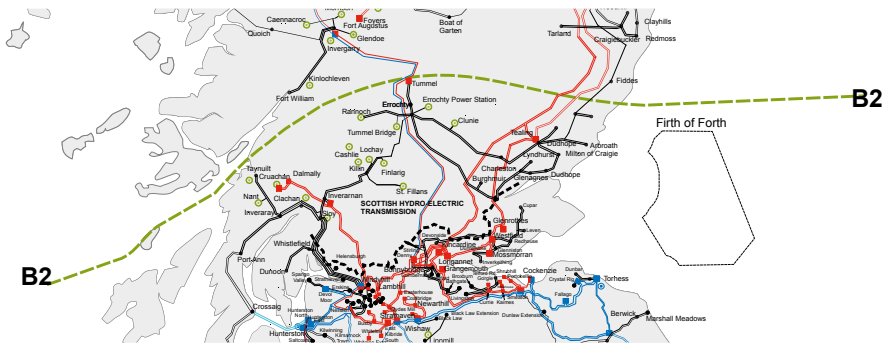

Boundary B2 cuts across the Scottish mainland from the east coast between Aberdeen and Dundee to near Oban on the west coast. The boundary cuts across the two 275 kV double circuits and a 132 kV single circuit in the east as well as the double circuit running southwards from Fort Augustus. As a result it crosses all the main north-south transmission routes from the north of Scotland. As described in boundary B1, the recently completed Beauly–Denny project is a key reinforcement that has increased the capability across boundaries B1, B2 and B4.

The generation behind boundary B2 includes both onshore and offshore wind, with the prospect of significant marine generation resource being connected in the longer term. There is also the potential for additional pumped storage plant to be located in the Fort Augustus area. The thermal generation at Peterhead lies between boundaries B1 and B2, as do several offshore windfarms and the proposed future North Connect interconnector with Norway.

# The electricity transmission network

**Figure B2.2**  
Required transfer and base capability for boundary B2

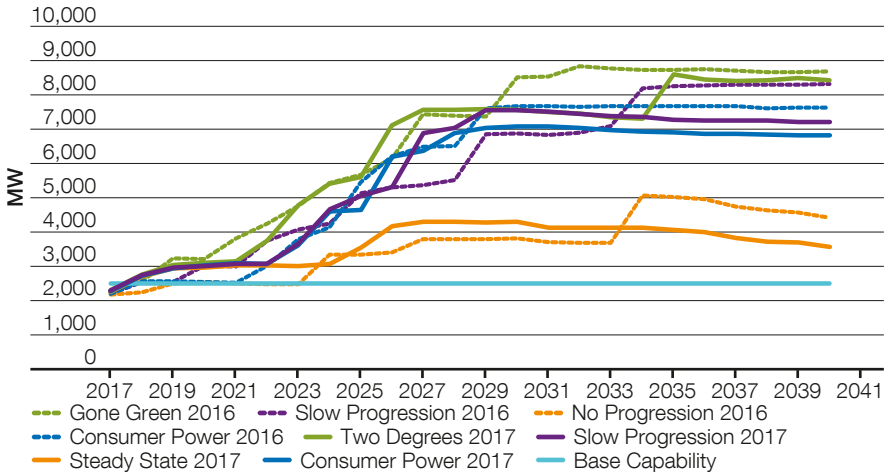

### Boundary requirements and capability

Figure B2.2 above shows the required boundary transfers for B2 from 2017 to 2040. The boundary capability is currently around 2.2GW.

The potential future boundary transfers for boundary B2 are increasing at a significant rate because of the high volume of contracted renewable generation seeking connection to the north of the boundary.

The recently completed Beaulieu to Denny reinforcement has provided significant additional network capacity and increases boundary B2's north-south capability. The increase in the required transfer capability for this boundary across all generation scenarios indicates the strong potential need to reinforce the transmission system further.

## Boundary B2a – Peterhead

*Figure B2a.1*  
Geographic representation of boundary B2a

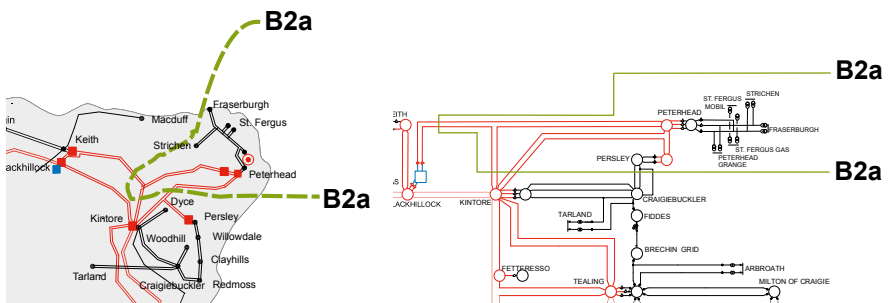

Boundary B2a is a local boundary enclosing the Peterhead area. The boundary cuts across the 275kV circuits from Peterhead to Blackhillock and Peterhead to Kintore, the 275kV circuit from Kintore to Blackhillock via Keith and the 275kV double circuit from Peterhead to Kintore via Persley. Peterhead power station is connected in this area and Moray Offshore Windfarm and North Connect interconnector are contracted to connect in

this area as well. There is limited capacity on the existing 275kV circuits to accommodate this and other generation connected to the 132kV network served by the 275kV network in this area.

A new local boundary, B2a, was created to facilitate the assessment of local network capacity requirements to accommodate power flows in this area.

# The electricity transmission network

**Figure B2a.2**  
 Required transfer and base capability for boundary B2a

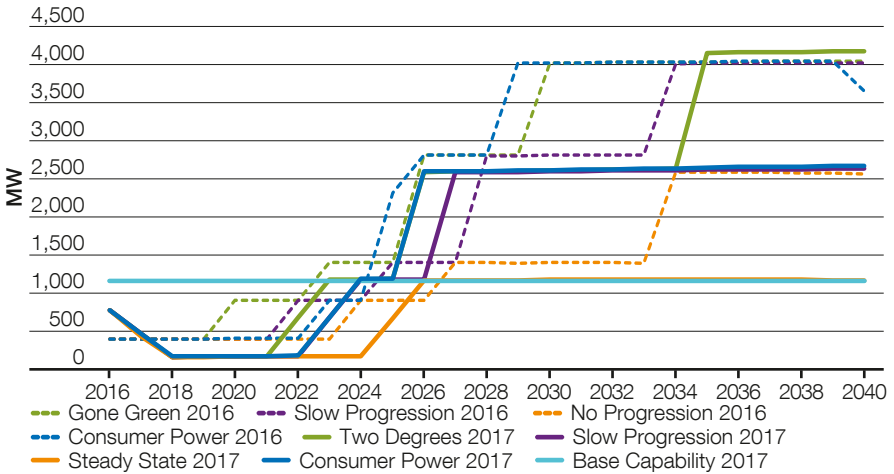
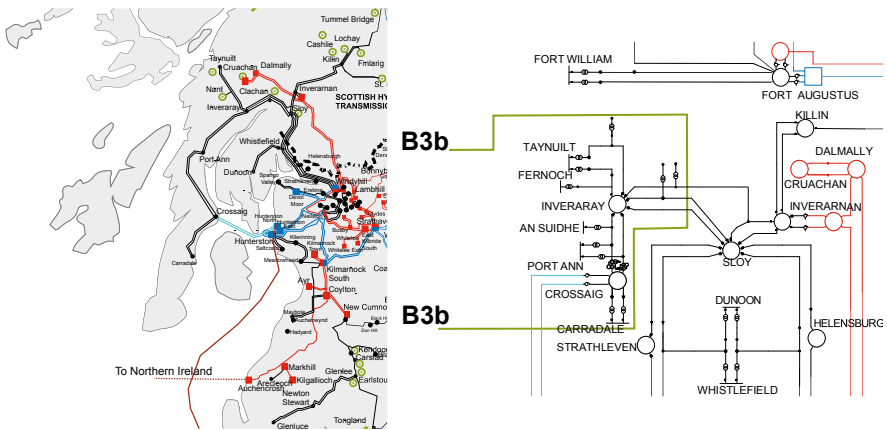

Figure B2a.2 above shows the required boundary transfers for B2a from 2017 to 2040. The boundary capability is currently around 1,160MW.

## Boundary B3b – Argyll and Kintyre

*Figure B3b.1*  
Geographic and single-line representation of boundary B3b



In the Argyll and Kintyre area the 132kV network is relatively weak with a low capacity, so a local boundary assessment is used to show limitations to generation power flow. Boundary B3b encompasses the Argyll and the Kintyre peninsula, cutting across the existing 132kV circuits between Inveraray and Sloy substations.

A key reinforcement has recently been completed in the Kintyre area, comprising two 220kV AC subsea cables between a new substation at Crossaig (to the north of Carradale) on Kintyre and Hunterston in Ayrshire. A 15km section of existing 132kV double circuit line between Crossaig and Carradale has also been rebuilt.

# The electricity transmission network

**Figure B3b.2**  
Required transfer and base capability for boundary B3b

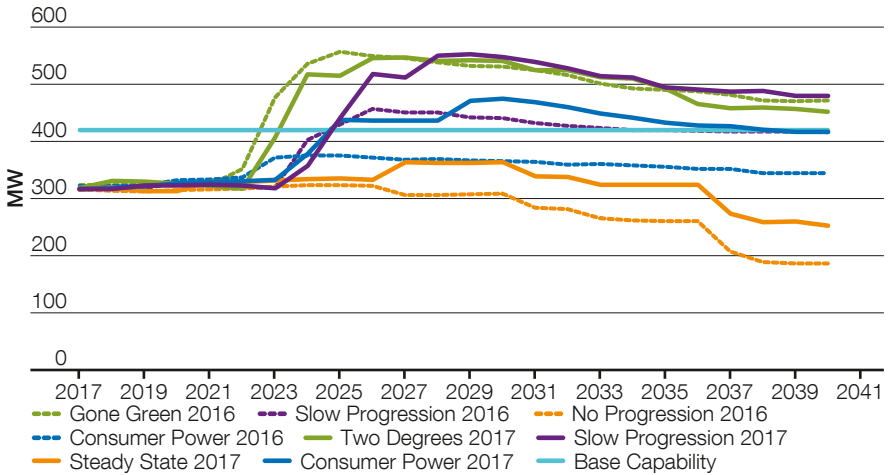

### Boundary requirements and capability

Figure B3b.2 above gives the required capability of the B3b boundary and a view of the maximum and minimum transfer requirements from 2017 to 2040. The current boundary capability is around 420MW.

The potential future power transfers across boundary B3b are increasing at a significant

rate because of the high volume of connected and contracted renewable generation seeking connection in Argyll and Kintyre. The recently completed Kintyre–Hunterston link has increased the capability of the boundary to 420MW. There is still significant interest and proposed connection activity in the area, and it is likely that further reinforcement of this network will be required in the future.



## Boundary B4 – SHE Transmission to SP Transmission

**Figure B4.1**  
Geographic representation of boundary B4

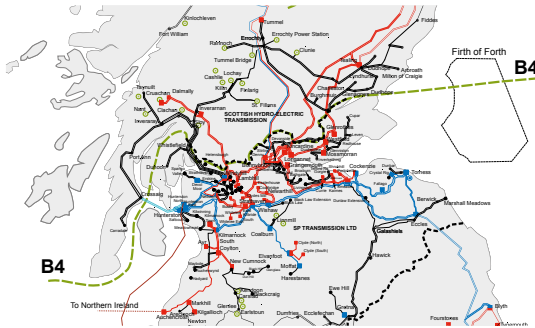

Boundary B4 separates the transmission network at the SP Transmission and SHE Transmission interface running from the Firth of Tay in the east to near the head of Loch Long in the west. With increasing generation in the SHE Transmission area for all generation scenarios, the required transfer across boundary B4 is expected to increase significantly over the period covered by the ETYS.

The boundary is crossed by two 275kV double circuits, one to Kincardine and one Westfield in the east, two 132kV double circuits from Sloy to Windyhill in the west, two 275/132kV auto-transformer circuits at Inverarnan and the recently commissioned double circuit to Denny North, one circuit of which operates at 400kV and the other at 275kV.

The recently completed Kintyre–Hunterston subsea link has provided two additional circuits crossing B4 between a new 132kV substation at Crossaig in Kintyre and the 400kV network at Hunterston in Ayrshire.

The prospective generation behind boundary B4 includes around 2.7GW from Rounds 1–3 and Scottish Territorial waters offshore wind located off the coast of Scotland.

# The electricity transmission network

**Figure B4.2**  
Required transfer and base capability for boundary B4

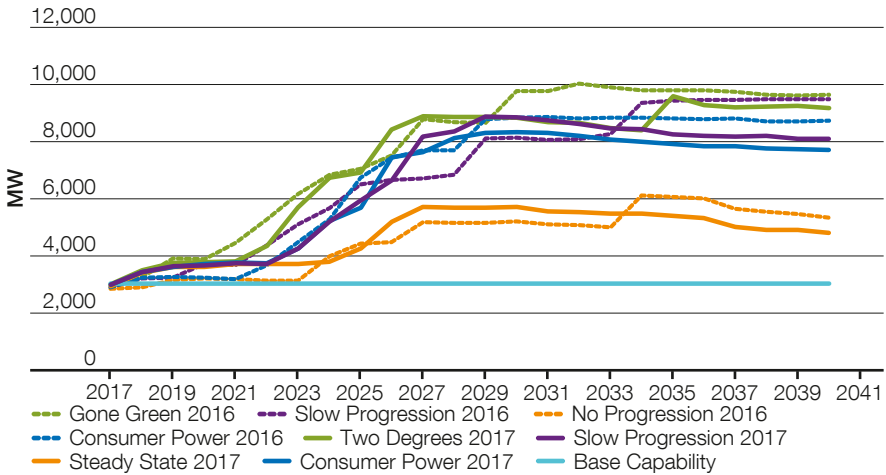

### Boundary requirements and capability

Figure B4.2 above shows the required boundary transfers for B4 from 2017 to 2040. The current boundary capability is around 3GW.

In all of the future energy scenarios, the power transfer through boundary B4 increases because of the significant volumes of generation connecting north of the boundary, including all generation above boundaries B0, B1 and B2. This is primarily onshore and offshore wind generation, with the prospect of significant marine generation resource being connected in the longer term.

The increase in the potential required transfer capability clearly indicates the strong potential need to reinforce the transmission network across boundary B4. The current boundary B4 capability is sufficient to satisfy the existing boundary transfer requirement as requirements are 3.4–3.5GW by winter 2018/19; however in the future B4 reinforcement may be required.

## Boundary B5 – North to South SP Transmission

*Figure B5.1*  
Geographic representation of boundary B5

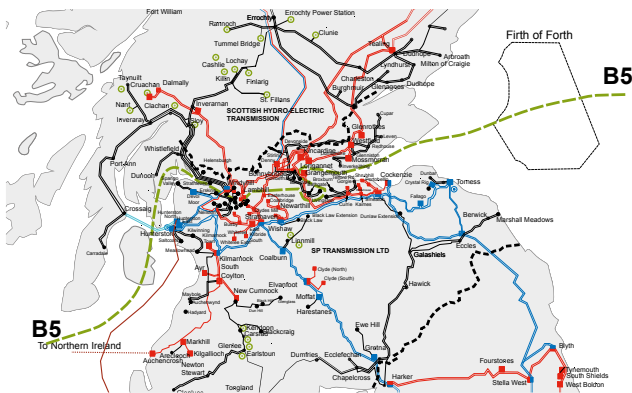

Boundary B5 is internal to the SP Transmission system and runs from the Firth of Clyde in the west to the Firth of Forth in the east. The generating station at Cruachan, together with the demand groups served from Windyhill, Lambhill, Bonnybridge, Mossmorran and Westfield 275kV substations, are located to the north of boundary B5. The existing

transmission network across the boundary comprises three 275kV double circuit routes: one from Windyhill 275kV substation in the west and one from each of Kincardine and Longannet 275kV substations in the east. The recently completed Kintyre–Hunterston subsea link also provides two additional circuits crossing B5.

# The electricity transmission network

**Figure B5.2**  
Required transfer and base capability for boundary B5

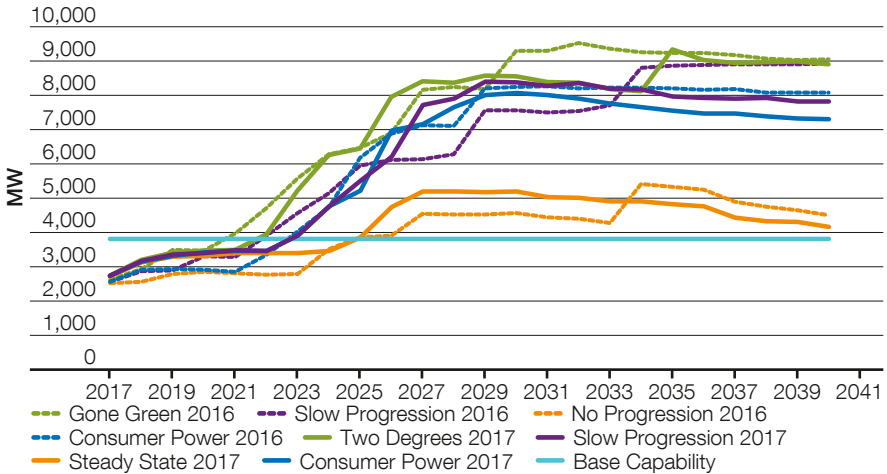

### Boundary requirements and capability

Figure B5.2 above shows the required boundary transfers for B5 from 2017 to 2040.

The capability of the boundary is presently limited by thermal considerations to around 3.7GW.

In all of the future energy scenarios there is a decrease in export (north to south) requirement over time, due to a Longannet decommissioning.

## Boundary B6 – SP Transmission to NGET

*Figure B6.1*  
Geographic representation of boundary B6

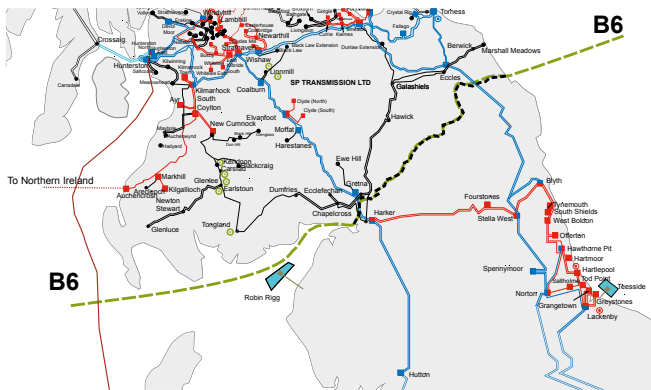

Boundary B6 separates the SP Transmission and the National Grid Electricity Transmission (NGET) systems. The existing transmission network across the boundary consists of two onshore double-circuit 400kV overhead line routes. These routes, from Gretna to Harker and from Eccles to Stella West, incorporate 400kV series compensation equipment (series capacitors). There are also some 132kV circuits across the boundary, which are of limited capacity.

Western Link is a major new HVDC scheme, employing direct current subsea and underground cables, between Hunterston in North Ayrshire and Deeside in Flintshire. Western Link has a rated voltage of 600kVdc and a continuous bi-directional power transfer capability of 2,250MW, significantly enhancing the capability of Boundary B6.

Peak power flow requirements are typically from north to south at times of high renewable generation output.

Large thermal and nuclear plants in Scotland continue to play a vital role in managing security of supply across Scotland. To secure the peak demand in Scotland at times of low wind generation output, approximately 3GW of generation will be required in Scotland. This generation could be provided by a variety of sites such as Torness, Hunterston, various pump storage and hydro schemes, and Peterhead. Following the completion of Western Link in 2017/18, this generation requirement is expected to fall to approximately 2.0GW.

Small embedded generation within Scotland can make a significant change to the boundary requirements.

# The electricity transmission network

**Figure B6.2**  
 Economy required transfer and base capability for boundary B6

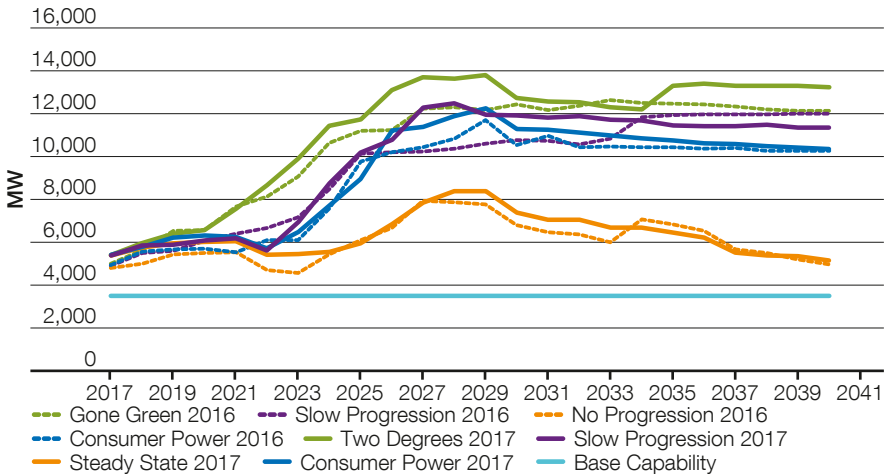

### Boundary requirements and capability

Figure B6.2 above shows the economy required transfers for boundary B6 from 2017 to 2040. The capability of boundary B6 is around 3.5GW.

Across all future energy scenarios there is an increase in the required export capability from Scotland to England due to the connection of additional generation in Scotland, primarily onshore and offshore wind. This generation increase is partially offset by the expected

closure of nuclear plants, the timing of which varies in each scenario. Similar to last year, the requirement for transfers above 6GW arises around 2021 at the earliest.

With the closure of conventional generation and variability of renewable generation output, consideration must be given to maintaining demand security. Figure B6.3 below shows the security required transfer for boundary B6 with power flow south to north represented at negative values.

**Figure B6.3**  
 Security required transfer and base capability for boundary B6

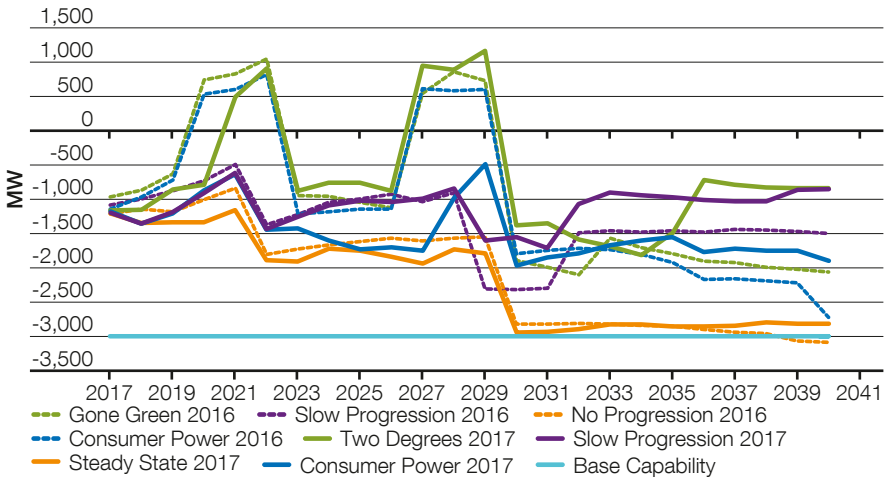

# The electricity transmission network

## 3.5 Network capability and requirements by region

### The North of England boundaries

#### Introduction

The North of England transmission region includes the transmission network between the Scottish border and the North Midlands. This includes the upper north boundaries B7, B7a and B8. The figure below shows likely

power flow directions in the years to come up to 2027. The arrows in the diagram are meant to illustrate power flow directions, but are not drawn to scale to reflect the magnitude of power flows.

**Figure 3.5**  
North of England transmission network

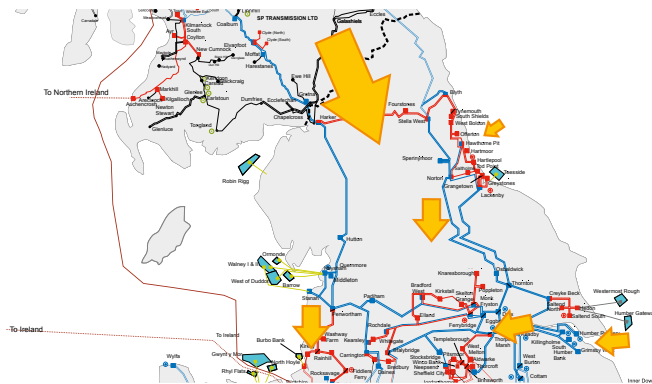

#### Primary challenge statement:

The connection of new generation and power flow through the region from Scotland heading south has the potential to cause overloading on the limited number of circuits across northern England. Future power transfer requirements could be more than double compared to what they are today.

region could expect between 13 and 22GW of generation connected by 2035. Depending on which scenario develops, the generation could trend towards increased renewables including offshore wind farms or could see growth in conventional generation. The demand in the region, as shown in figure NE.2, could reasonably be expected to increase as can be seen for most of the scenarios, and in the **Consumer Power** scenario could outstrip generation capacity in the region.

#### Regional drivers

According to the future energy scenarios graph below (NE.1), the northern transmission



**Figure NE.1**  
*Generation mix scenarios for the North of England*

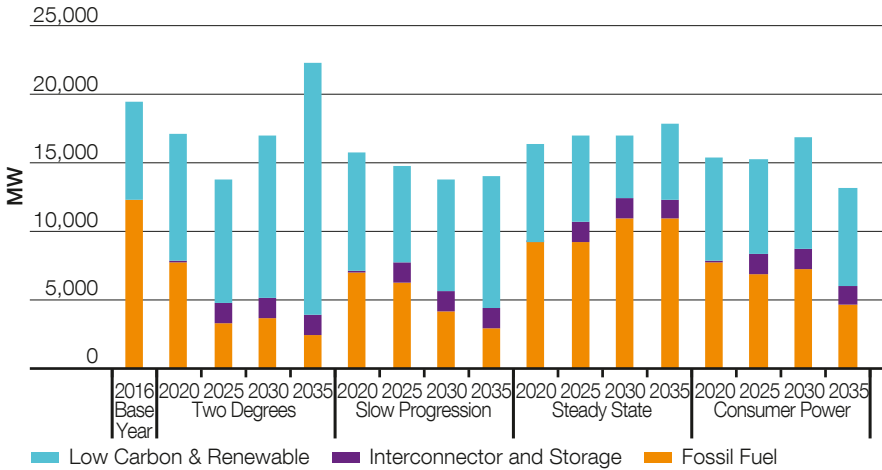

**Figure NE.2**  
*Gross demand scenarios for the North of England*

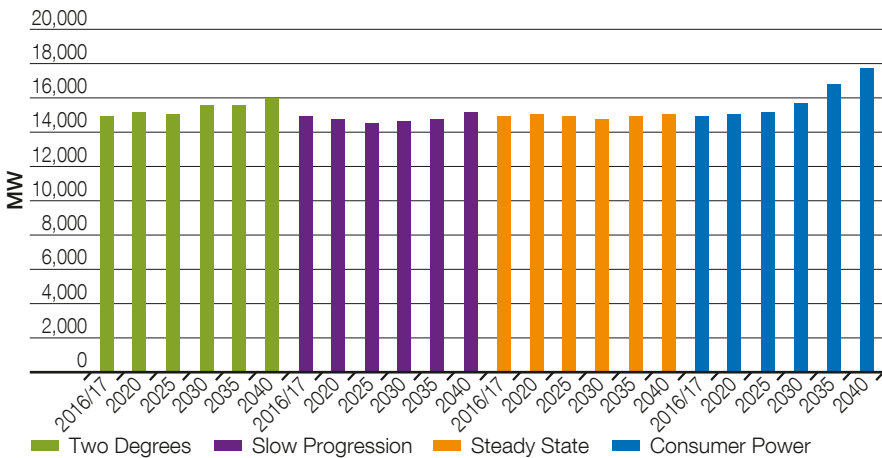

# The electricity transmission network

Presently, most of the northern transmission network is oriented for north–south power flows with connections for demand and generation along the way. At times of high wind generation the power flow will mostly be from north to south, with power coming from both internal boundary generation and generation further north in Scotland. When most of this area and Scotland is generating power, transmission capability can be very limited. The loss of one of the north to south routes can have a very high impact on the remaining circuits.

The Western HVDC Link and the series and shunt compensation assets are set to increase the capability of the northern boundaries to adequately transfer the potential bulk electricity from Scotland to England.

In addition, voltages in the northern region are being managed carefully with operational reactive switching. This helps to manage the significant voltage drop due to reactive power demands which arise when high levels of power flow on long circuits. Operational reactive switching solutions are also used to manage light loading conditions when the voltage can rise to unacceptable levels.

The high concentration of large conventional generators around Humber and South Yorkshire means that system configuration can be limited by high fault levels. Therefore some potential network capability restrictions in the north can be due to the inability to configure the network as desired due to fault level concerns.

As the potential future requirement to transfer more power from Scotland to England increases, B7 and B7a are likely to reach their capability limits and may potentially need network reinforcement. The potential future restrictions to be overcome across B7 and B7a are summarised:

- Limitation on power transfer out of North East England (boundary B7) is caused by the north to south flow across two sets of 400kV double circuits: Norton–Osballdwick–Thornton and Lackenby–Thornton. As the North East England area increases its exports, these circuits will eventually reach their thermal limit.
- At high power transfer thermal limitations occur on a number of circuits within the North East 275kV ring.
- Limitation on power transfer from Cumbria to Lancashire (boundary B7a) occurs as power flows via two branches of circuits: a 400kV branch of Penwortham–Padiham/Carrington and a 275kV branch of Penwortham–Kirkby. The boundary capability is limited by voltage compliance for a fault on the three ended circuits between Heysham, Hutton and Penwortham.

The need for network reinforcement to address the above mentioned potential capability issues will be evaluated in the *NOA 2017/18* cost benefit analysis. Following the evaluation, the preferred reinforcements for the North of England region will be recommended.

## Boundary B7 – Upper North

*Figure B7.1*  
Geographic representation of boundary B7

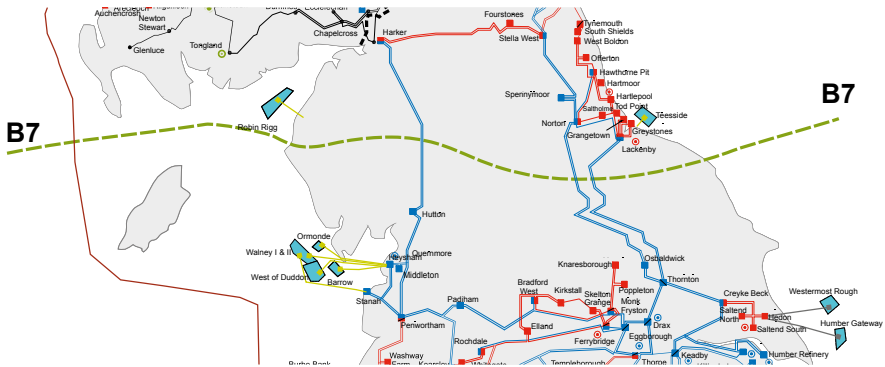

Boundary B7 bisects England south of Teesside. It is characterised by three 400kV double circuits, two in the east and one in the west, and the Western HVDC link. The area between B6 and B7 has been traditionally

an exporting area, and constrained by the power flowing through the region from Scotland towards the south with the generation surplus from this area added.

# The electricity transmission network

**Figure B7.2**  
 Economy required transfer and base capability for boundary B7

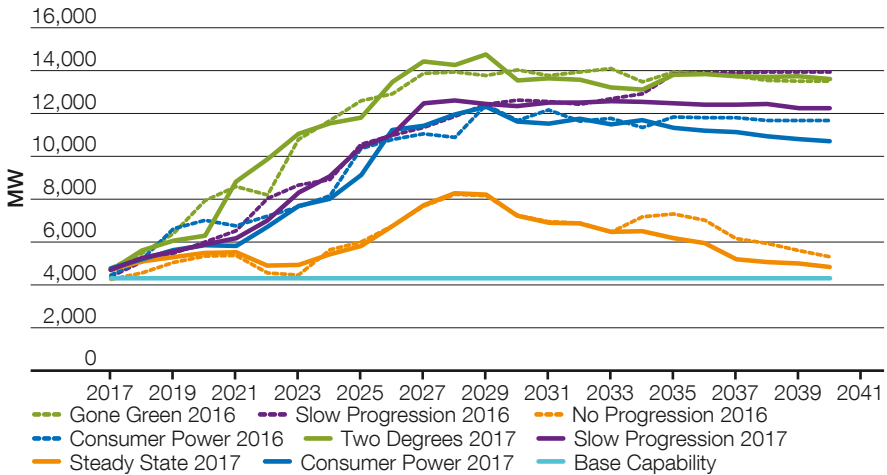

### Boundary requirements and capability

Figure B7.2 above shows the economy required transfers for boundary B7 from 2017 to 2040. The boundary capability is limited by voltage compliance at 4.3GW for a fault on the three ended circuits between Heysham, Hutton and Penwortham.

All the scenarios suggest an increase in future requirements due to the increase of generation north of boundary B7. Although ageing coal, gas and nuclear plants are closing north of the boundary across these scenarios, this is offset by the vast amount of onshore and offshore wind being commissioned. The only scenario not showing a significant build-up is **Steady State** – this is mainly due to the lack of significant

offshore and onshore wind connections after 2021 as they are either delayed or do not connect at all in this scenario.

The required transfer for B7 will also greatly vary depending on the operation of the several interconnectors planned to connect north of the boundary. With these interconnectors importing to the GB system, B7 required transfers would increase.

The security required transfer for boundary B7 places requirement for capability for south to north power flow as shown in figure B7.3. Capability is expected to be sufficient to meet the capability requirements in the near future, with potential need to improve capability further in the future.

**Figure B7.3**  
Security required transfer for boundary B7

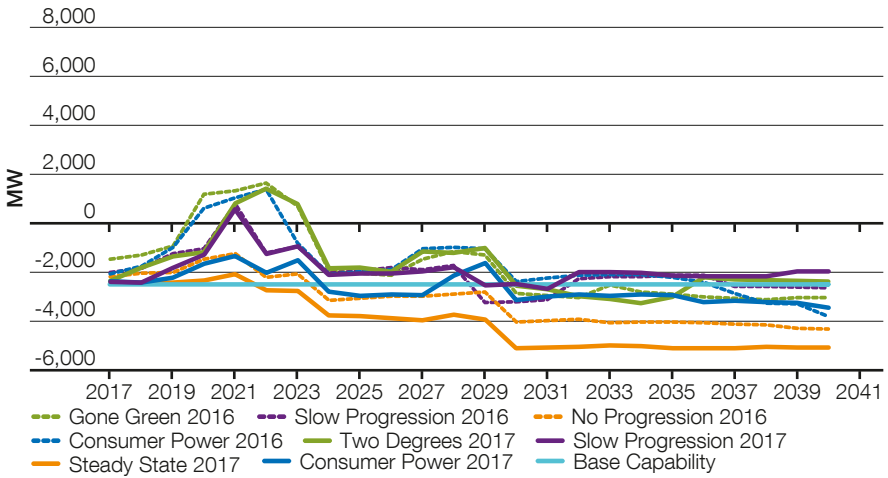

# The electricity transmission network

## Boundary B7a – Upper North

*Figure B7a.1*  
Geographic representation of boundary B7a

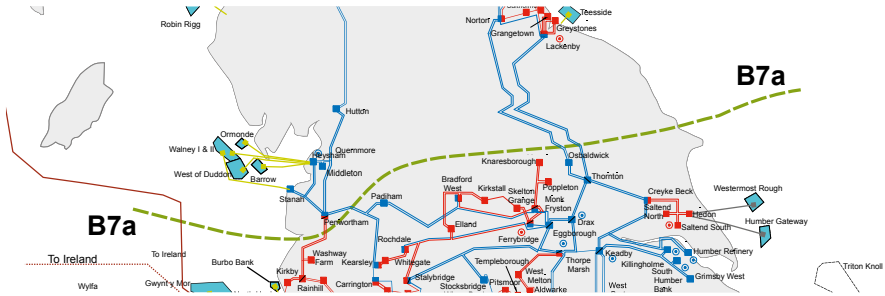

Boundary B7a bisects England south of Teesside and into the Mersey Ring area. It is characterised by three 400kV double circuits (two in the east, one in the west), one 275kV circuit and the Western HVDC link. Between boundaries B6 and B7a was traditionally an exporting area with a surplus of generation

– when added to the exported power from Scotland this puts significant requirements on boundary B7a. In the future a large amount of onshore and offshore wind connecting north of this boundary increases the transfer requirements.

**Figure B7a.2**  
 Economy required transfer and base capability for boundary B7a

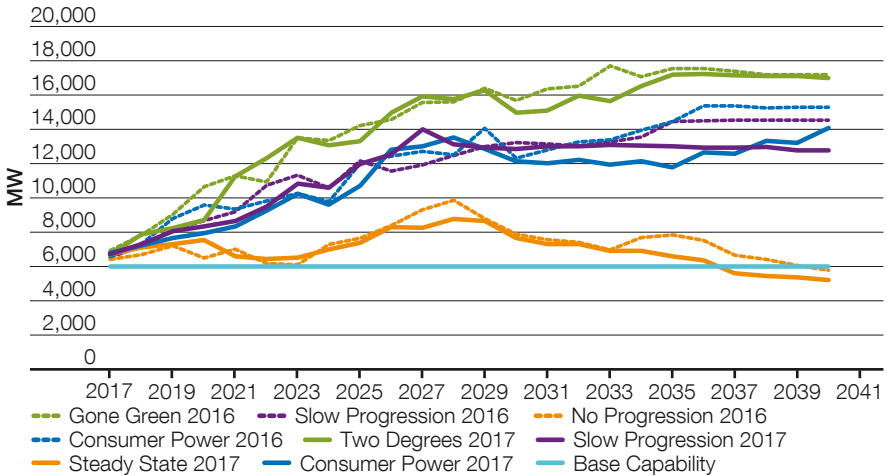

**Boundary requirements and capability**

Figure B7a.2 above shows the economy required transfers for boundary B7a from 2017 to 2040. The boundary capability is thermally limited at around 6GW for an overlapping fault involving the Penwortham–SGT6 and Carrington–Penwortham circuit which overloads the Padiham–Penwortham circuit.

Across all scenarios the required transfer increases until 2020 when **Steady State** declines for the next three years. Other scenarios will still see the growth where

in particular **Two Degrees** has a higher rate compared to others. The rapid increase is due to a number of onshore and offshore wind farm connections in England and Scotland, fewer of these are part of the **Steady State** scenario.

Similar to the other boundaries further north with a lot of wind capacity behind them, boundary B7a has a security requirement to ensure demand is met when the intermittent generation is not operational. Figure B7a.3 below shows the security required transfer for boundary B7a.

# The electricity transmission network

**Figure B7a.3**  
Security required transfer for boundary B7a

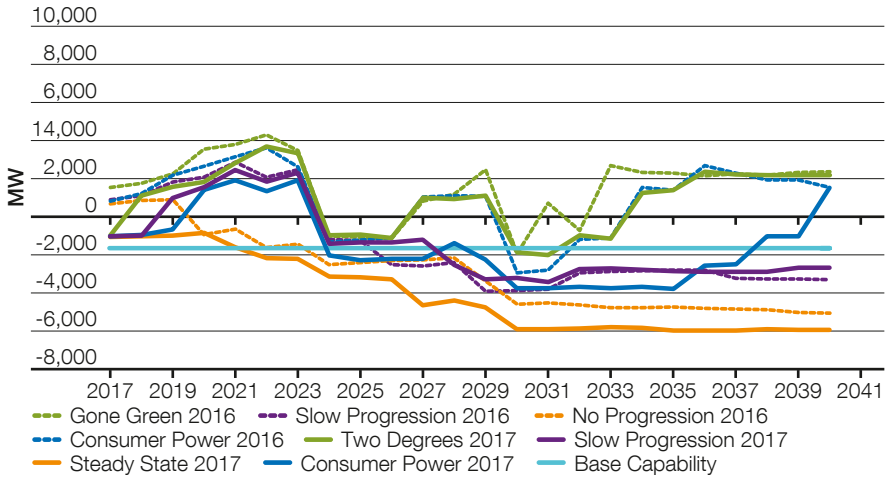



## Boundary B8 – North to Midlands

*Figure B8.1*  
Geographic representation of boundary B8

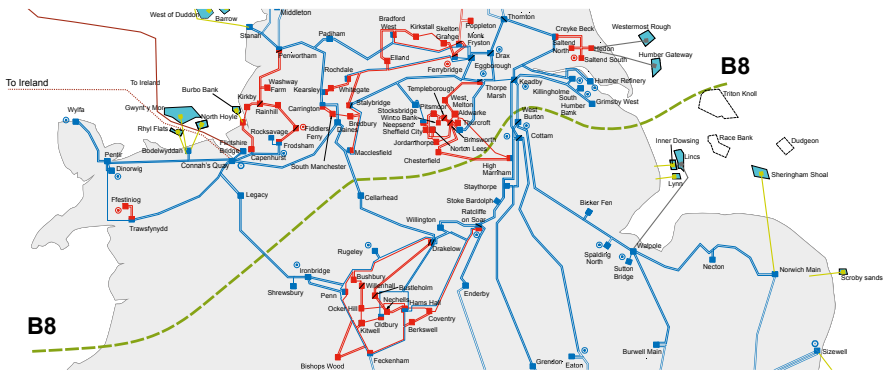

The North to Midlands boundary B8 is one of the wider boundaries that intersects the centre of GB, separating the northern generation zones including Scotland, Northern England and North Wales from the Midlands and southern demand centres. The boundary crosses four major 400kV

double circuits, with two of those passing through the East Midlands while the other two pass through the West Midlands and a limited 275kV connection to South Yorkshire. Power generated from Scotland continues to be transported south, leading to the high transfer level across B8.

# The electricity transmission network

**Figure B8.2**  
Required transfer and base capability for boundary B8

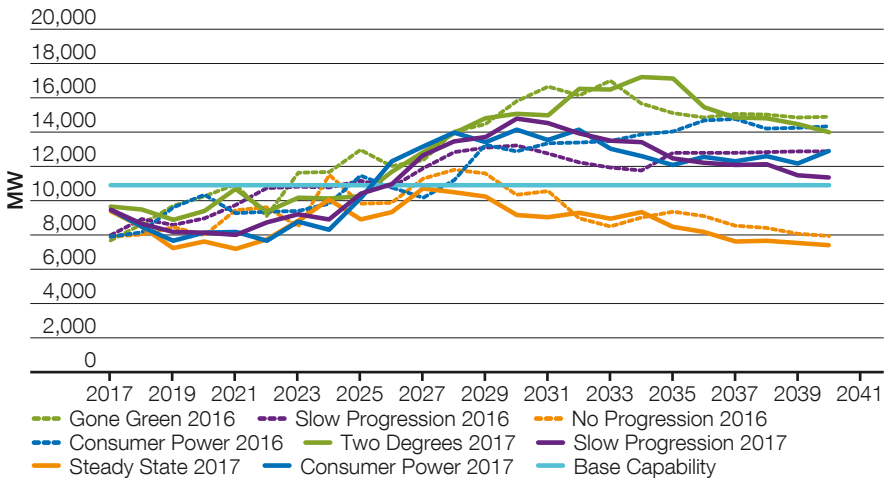

### Boundary requirements and capability

Figure B8.2 shows the required transfer for boundary B8 from 2017 to 2040. The boundary capability is thermally limited to 10.75GW when a double circuit fault on the Connah’s Quay–Trawsfynydd or Trawsfynydd–Legacy circuits overloads the Cellarhead–Drakelow circuit. While for the **Two Degrees** scenario there is a steady increase in required transfer from 2022 to 2034, **Slow Progression** and **Consumer Power** flatten out from 2030. Further, the required transfer under the **Steady State** scenario starts to decrease after 2027.

### Gone Green 2016 and Two Degrees 2017

2016 and **Two Degrees** 2017 diverge between 2022 and 2026 and then between 2034 and 2036. This is mainly due to a number of offshore wind projects that are expected to connect later or have their overall capacity reduced in the **Two Degrees** 2017 scenario. Changes regarding the dispatch assumptions or connection dates of existing or future Interconnectors further contribute to this.

## 3.6 Network capability and requirements by region

### Wales and the Midlands boundaries

#### Introduction

The Western transmission region includes boundaries in Wales and the Midlands. The figure below shows likely power flow

directions in the years to come up to 2027. The arrows in the diagram are to illustrate power flow directions but are not drawn to scale to reflect the magnitude of power flows.

**Figure 3.6**  
*Wales and Midlands transmission network*

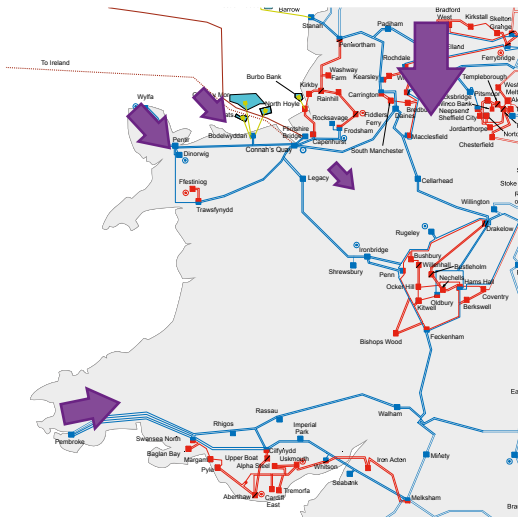

**Primary challenge statement:** Future nuclear generation connecting in North Wales, low-carbon and the new interconnectors with Ireland have the potential to drive increased power flows eastward into the Midlands where power plant closures are set to occur and demand set to remain fairly high.

**Regional drivers** By 2035, all the future energy scenarios indicate an overall reduction in the total amount of generation in the region (see figure WM.1). At present, this region has significant levels of fossil fuel (about 18 GW), most of which is set to close and be replaced by a combination of low carbon technologies, interconnectors and storage.

# The electricity transmission network

**Figure WM.1**  
*Generation mix scenarios for Wales and the Midlands*

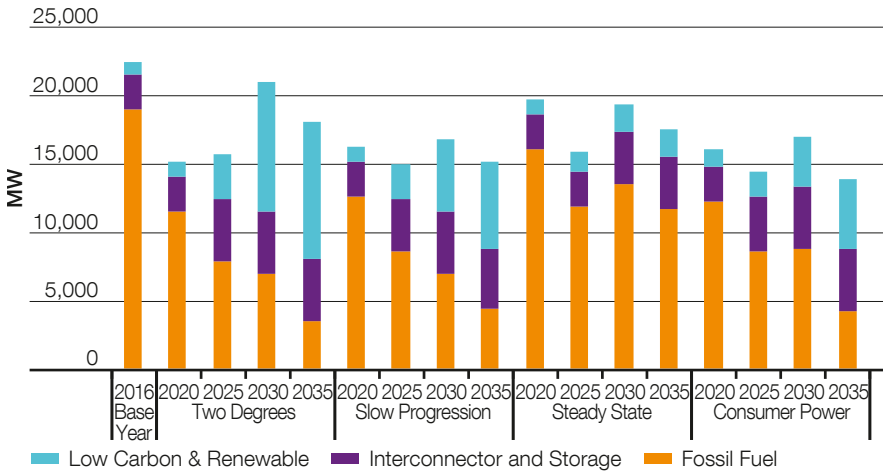
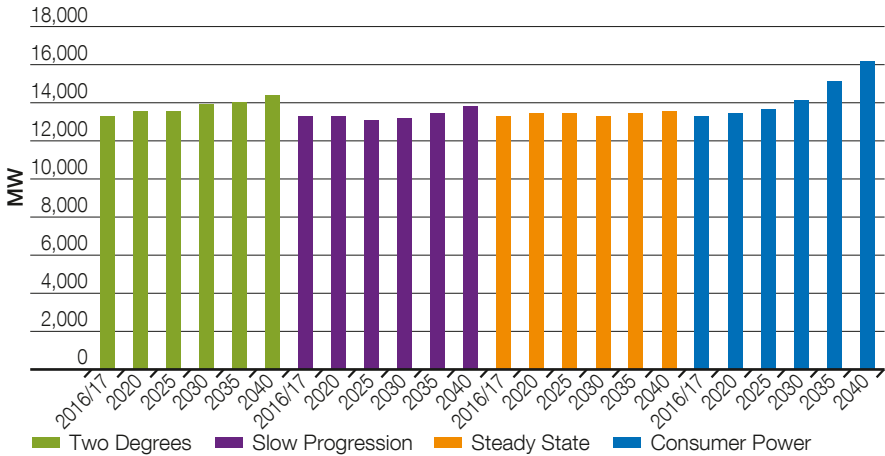

Figure WM.2 shows that the demand as seen from the transmission network in the region will increase across all scenarios.

This is driven by the adoption of technologies such as electric vehicles, heat pumps and embedded storage.

**Figure WM.2**  
Gross demand scenarios for Wales and the Midlands



The majority of expected westerly increases in generation are from low carbon technologies, embedded generation and interconnectors. Most of this is expected in the Wales region.

The transmission network in North Wales consists of only nine 400kV double circuits with limited capacity which are likely to be stressed to their capability limits if much

of the new future generation connects. The potential limitation on future power exports are covered by boundaries NW1, NW2, and NW3.

The NOA 2017/18 will assess the above mentioned potential scenarios and accordingly recommend preferred reinforcements for this Western transmission region.

# The electricity transmission network

## Boundary B9 – Midlands to South

*Figure B9.1*  
Geographic representation of boundary B9

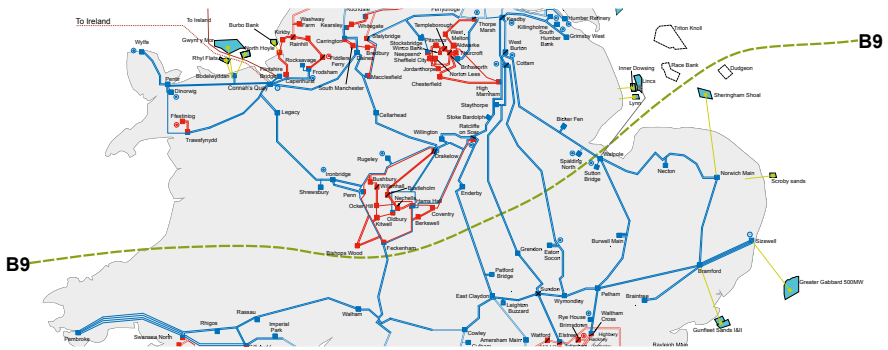

The Midlands to South boundary B9 separates the northern generation zones and the southern demand centres. The boundary crosses five major 400kV double circuits, transporting power from the north over a long distance to the southern demand hubs,

including London. Developments in the East Coast and the East Anglia regions, such as the locations of offshore wind generation connection and the network infrastructure requirements, will affect the transfer requirements and capability of boundary B9.

**Figure B9.2**  
Required transfer and base capability for boundary B9

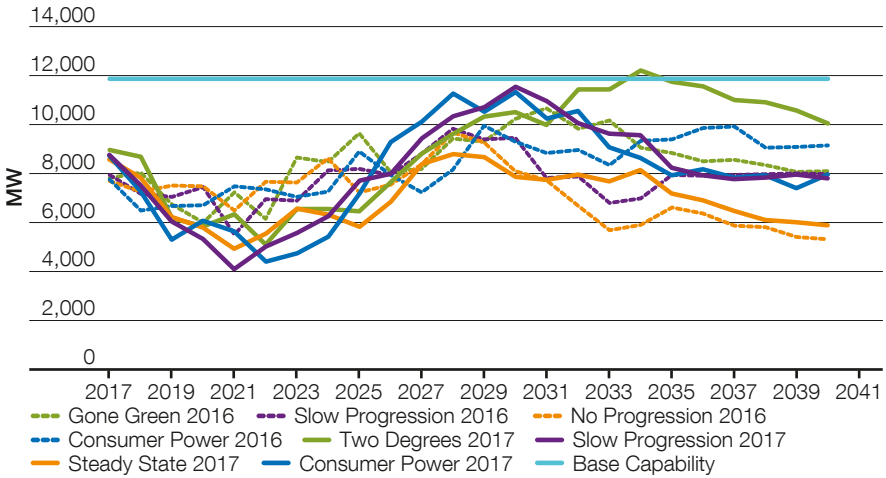

**Boundary requirements and capability**

Figure B9.2 above shows the required transfers for boundary B9 from 2017 to 2040. The boundary capability is thermally limited at 11.9GW for a combined fault on the first Grendon–Sundon circuit and the High Marnham Super Grid transformer which overloads the second Grendon–Sundon circuit.

Across all scenarios there is a difference between this year’s and last year’s required transfers for boundary B9. This is mainly due to early closure of existing plants and late replacement by wind generation. Also, with the number of interconnectors planning to connect north of the boundary, the required transfers of boundary B9 will vary greatly depending on the operation of these interconnectors.

# The electricity transmission network

## North Wales – overview

The onshore network in North Wales comprises a 400kV circuit ring that connects Pentir, Deeside and Trawsfynydd substations. A 400kV double-circuit spur crossing the Menai Strait and running the length of Anglesey connects the now decommissioned nuclear power station at Wylfa to Pentir. A short 400kV double-circuit cable spur from Pentir connects Dinorwig pumped

storage power station. In addition, a 275kV spur traverses north of Trawsfynydd to Ffestiniog pumped storage power station. Most of these circuits are of double-circuit tower construction. However, Pentir and Trawsfynydd within the Snowdonia National Park are connected by a single 400kV circuit, which is the main limiting factor for capacity in this area.

*Figure NW.1*  
Geographic representation of North Wales boundaries

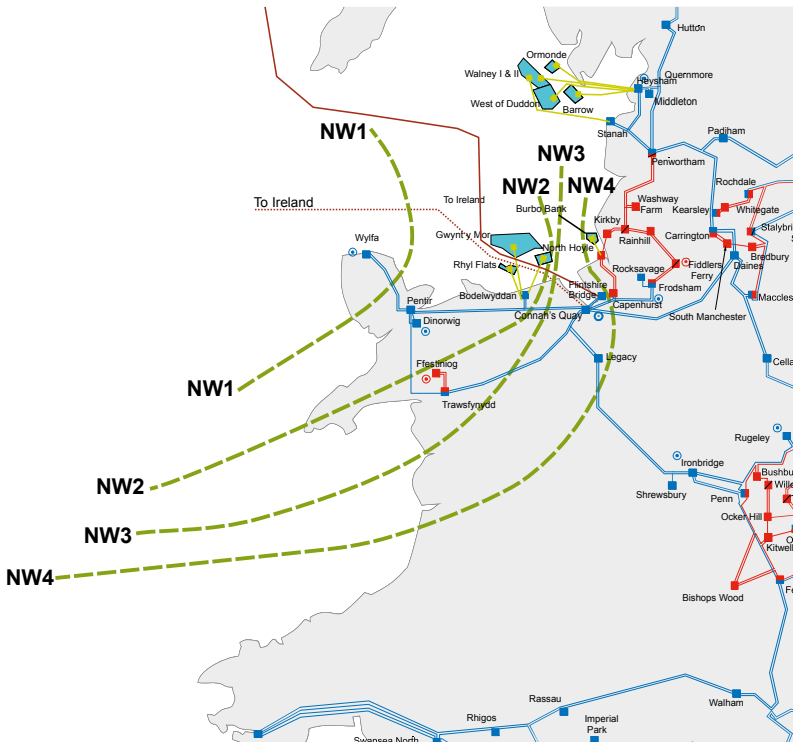



## Boundary NW1 – Anglesey

*Figure NW1.1*  
Geographic and single-line representation of boundary NW1

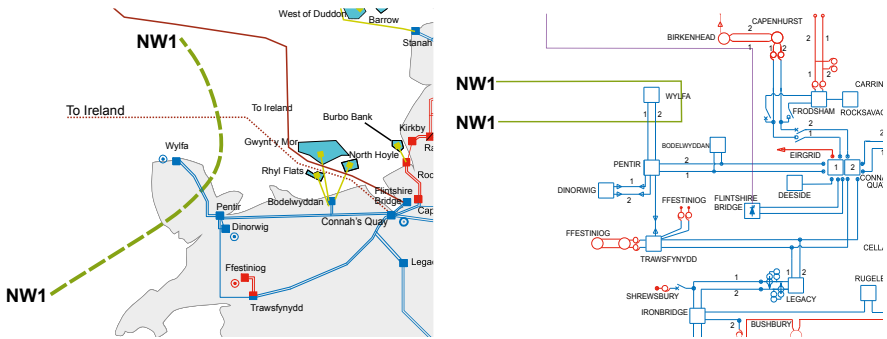

Boundary NW1 is a local boundary crossing the 400kV double circuit that runs along Anglesey between Wyifa and Pentir substations.

# The electricity transmission network

**Figure NW1.2**  
Boundary export requirements and base capability for boundary NW1

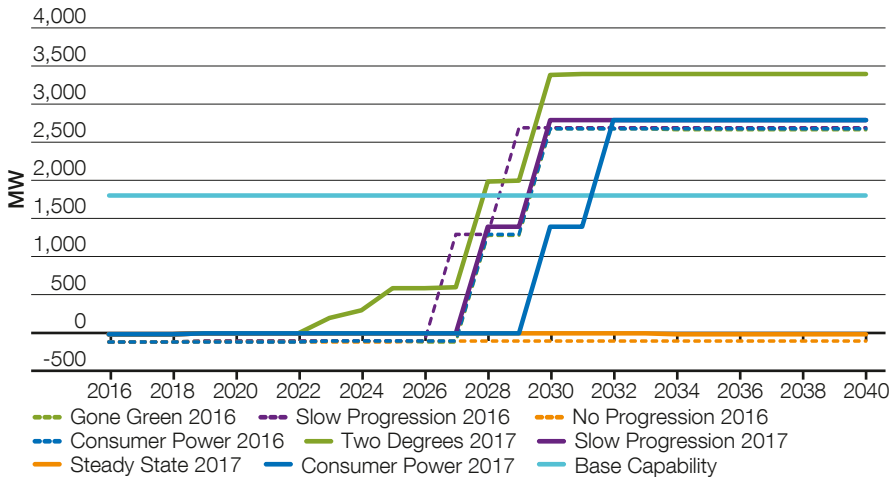

### Boundary requirements and capability

Figure NW1.2 above shows the export requirements for boundary NW1 from 2017 to 2040. The boundary transfer capability is limited by the infrequent infeed loss risk criterion set in the SQSS, which is currently 1,800MW. If the infrequent infeed loss risk is exceeded, the boundary will need to be reinforced by adding a new transmission route across the boundary.

The future energy scenarios all show a similar requirement until 2026 where they diverge. The only large-scale generation expected behind NW1 is a new nuclear power station which appears in the background in two stages and within different time horizons. This power station is not expected to be in the background generation as per the **No Progression** energy scenario.

## Boundary NW2 – Anglesey and Caernarvonshire

*Figure NW2.1*  
Geographic and single-line representation of boundary NW2

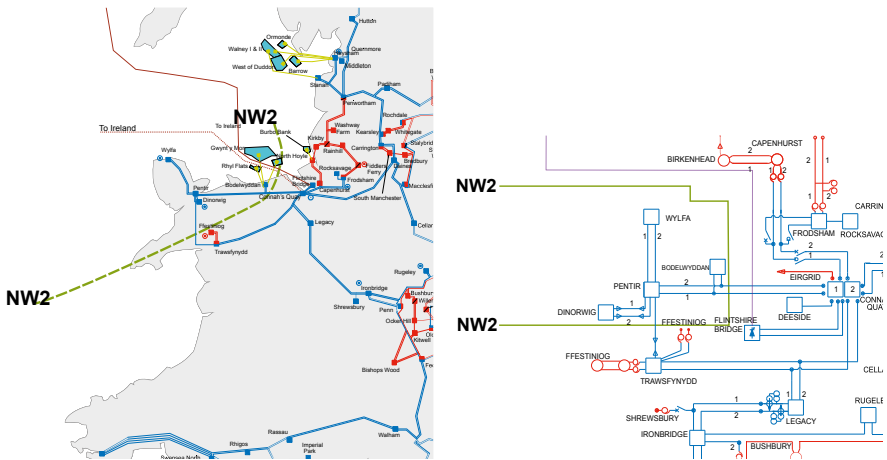

This local boundary bisects the North Wales mainland close to Anglesey and crosses through the Pentir to Deeside 400kV double circuit and Pentir to Trawsfynydd 400kV single circuit.

# The electricity transmission network

**Figure NW2.2**  
Boundary export requirements and base capability for boundary NW2

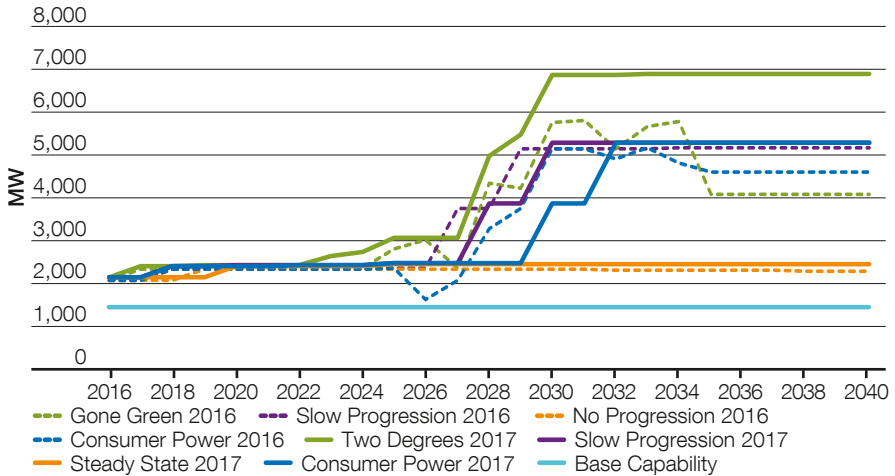

### Boundary requirements and capability

Figure NW2.2 above shows the export requirements for boundary NW2 from 2017 to 2040. The boundary capability is thermally limited at 1.4GW for a double circuit fault on the Deeside–Pentir circuits which overloads the Pentir–Trawsfynydd single circuit.

The future energy scenarios all show a similar requirement until 2024 where they diverge due to different assumptions of connection time and dispatching of potential interconnector, wind and nuclear generation behind this boundary.

## Boundary NW3 – Anglesey and Caernarvonshire and Merionethshire

*Figure NW3.1*  
Geographic and single-line representation of boundary NW3

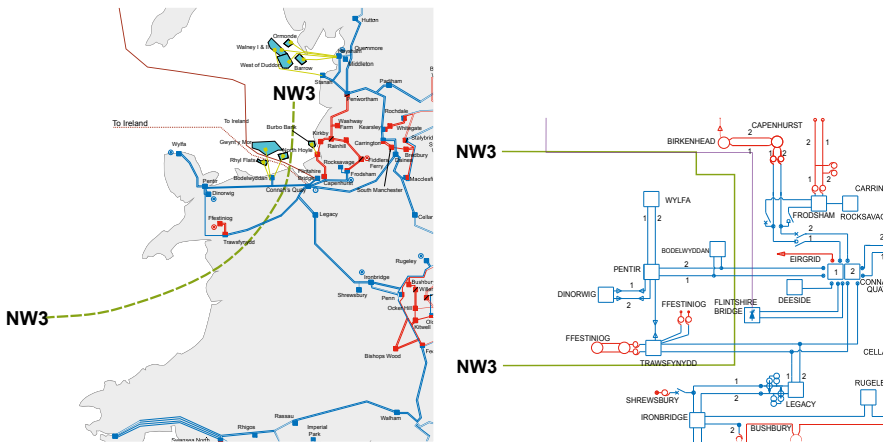

Boundary NW3 provides transfer capability for further generation connections in addition to those behind NW1 and NW2.

This boundary is defined by a pair of 400kV double circuits from Pentir to Deeside and Trawsfynydd to the Treuddyn Tee.

# The electricity transmission network

**Figure NW3.2**  
Boundary export requirements and base capability for boundary NW3

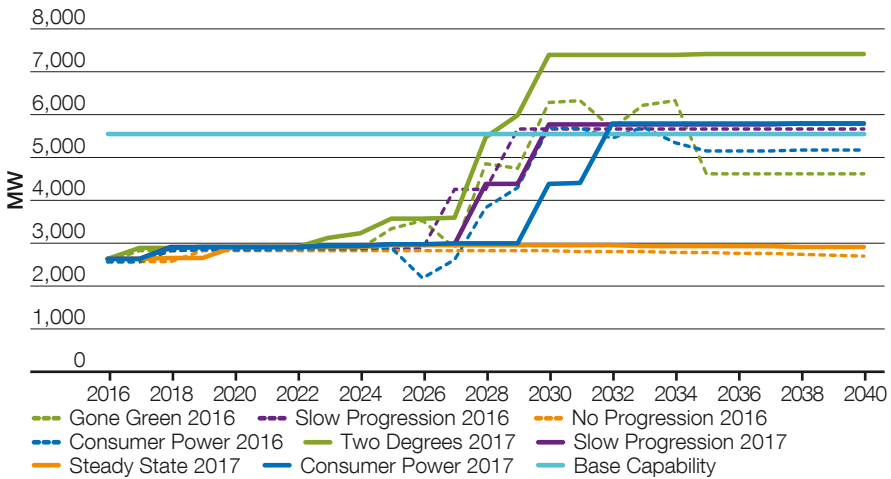

### Boundary requirements and capability

Figure NW3.2 above shows the export requirements for boundary NW3 from 2017 to 2040. The boundary capability is thermally limited at 5.6GW for a double-circuit fault on the Trawsfynydd–Treuddyn Tee circuits which overloads the Deeside–Bodelwyddan Tee circuits.

The future energy scenarios all show a similar requirement until 2024 where they diverge due to different assumptions of connection time and dispatching of potential interconnector, wind and nuclear generation behind this boundary.

## 3.7 Network capability and requirements by region

### Eastern boundaries

#### Introduction

The East of England region includes the counties of Norfolk and Suffolk. The figure below shows likely power flow directions

in the years to come up to 2027. The arrows in the diagram are meant to illustrate power flow directions and are not drawn to scale to reflect the magnitude of power flows.

**Figure 3.7**  
*East England transmission network*

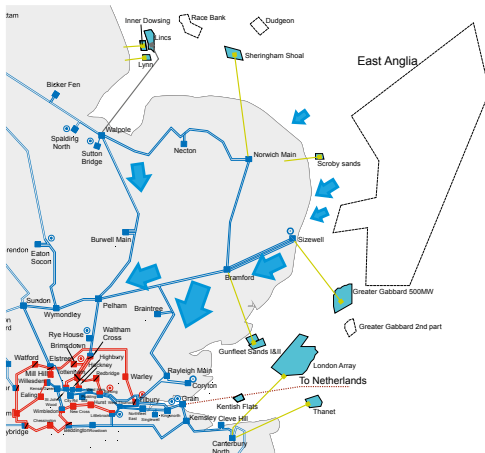

#### Primary challenge statement:

With the large amount of generation contracted to be connected, predominantly offshore wind and nuclear, in the area, supply may significantly exceed the local demand which could cause heavy circuit loading, voltage depressions and stability issues.

#### Regional drivers:

The future energy scenarios highlight that generation between 5 and 16.5GW could be expected to connect within this region by 2035. All scenarios show that, in the years to come, large amounts of low carbon generation, predominantly wind, can be expected to connect. Fossil fuel generation can also be expected to connect within this region. The total generation in all the scenarios will exceed the local demand, thus East Anglia will be a power exporting region.

# The electricity transmission network

**Figure EE.1**  
Generation mix scenarios for the Eastern boundaries' region

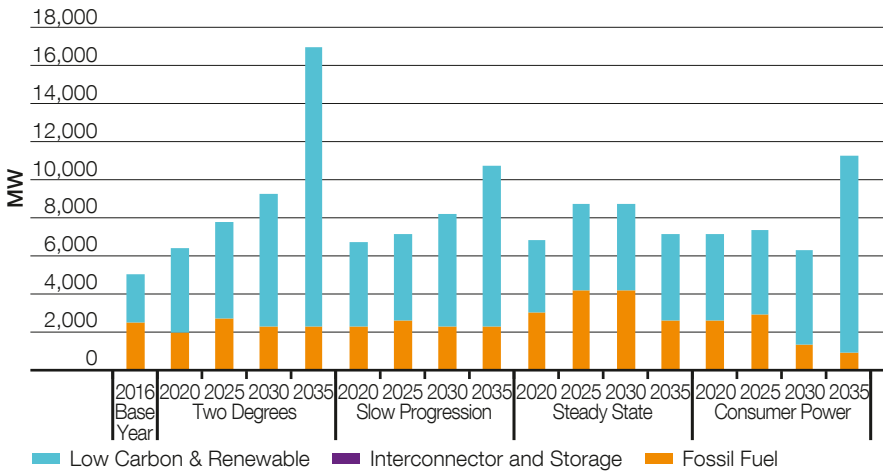

**Figure EE.2**  
Gross demand scenarios for the East of England

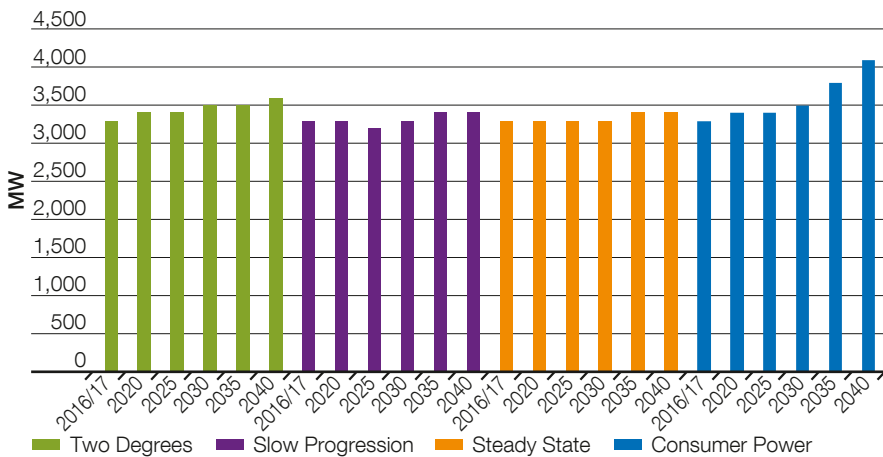



Peak demand in the Eastern region is expected to lie between 3.3 and 4.1 GW by 2035. The graph above shows snapshots of the peak demand for the East of England across the four different future energy scenarios.

The East Anglia transmission network to which the future energy scenarios generation will connect has eight 400kV double circuits. The potential future increase in generation within this region (and including the impact of interconnector flows from the West Midlands to the south of England through East Anglia) could force the network to experience very heavy circuit loading, stability issues and voltage depressions – for power transfer scenarios from East Anglia to London and south-east England. This is explained as follows:

- The East of England region is connected by several sets of long 400kV double circuits, including Bramford Pelham/ Braintree, Walpole–Spalding North/Bicker Fen and Walpole–Burwell Main. During a fault on any one set of these circuits, power exported from this region is forced to reroute. This causes some of the power to flow through a much longer distance to reach the rest of the system, predominantly the Greater London and south-east England networks via the East Anglia region. As a result, the reactive power losses in these high impedance routes will also increase. If these losses are not compensated they will eventually lead to voltage depressions within the region.

- Stability becomes an additional concern when some of the large generators connect, further increasing the size of the generation group in the area connected to the network. Losing a set of double circuits when a fault occurs will lead to significant increases in the impedance of the connection between this large generation group and the remainder of the system. As a result, the system may be exposed to a risk of instability as power transfer increases.
- It is also important to ensure that all the transmission routes in the area will have sufficient thermal capacity to cope with the increase in export requirement under post-fault conditions.

The NOA 2017/18 will assess the likelihood and impact of the above mentioned potential scenarios and accordingly recommend preferred reinforcements for the East of England transmission region.

# The electricity transmission network

## Boundary EC5 – East Anglia

*Figure EC5.1*  
Geographic and single-line representation of boundary EC5

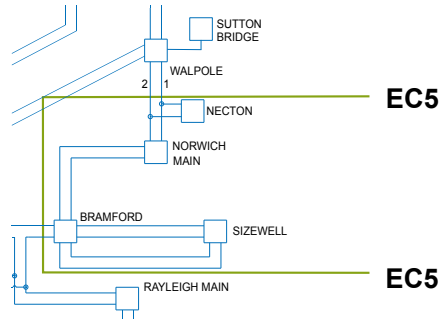
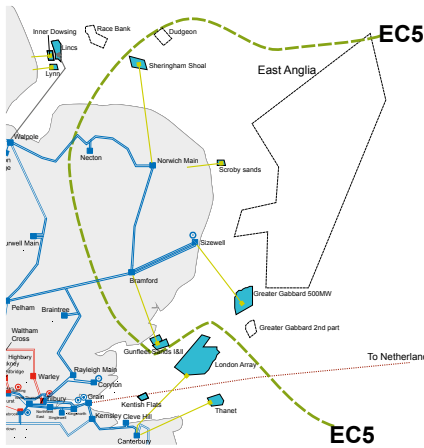

Boundary EC5 is a local boundary enclosing most of East Anglia with 400kV substations at Norwich, Sizewell and Bramford. It crosses four 400kV circuits that mainly export power towards London.

The coastline and waters around East Anglia are attractive for the connection of offshore wind projects including the large East Anglia Round 3 offshore zone that lies directly to the east. The existing nuclear generation site at Sizewell is one of the approved sites selected for new nuclear generation development.

**Figure EC5.2**  
Boundary export requirements and base capability for boundary EC5

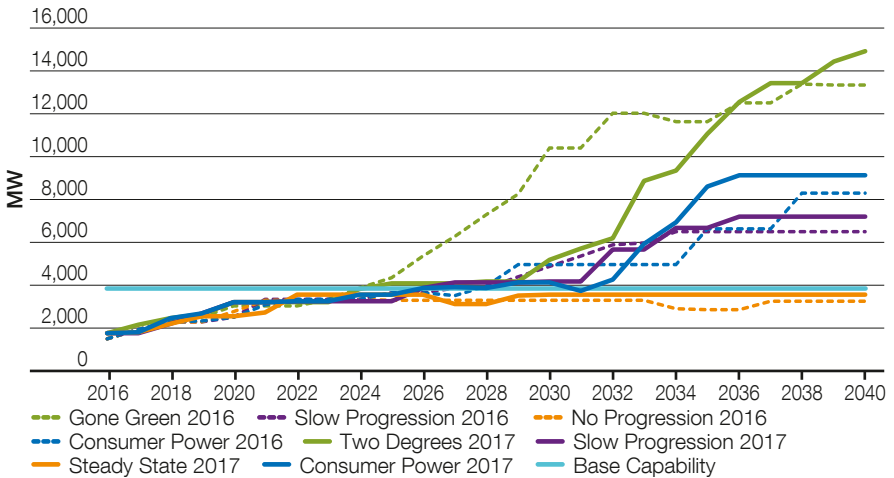

**Boundary requirements and capability**

Figure EC5.2 above shows the export requirements for boundary EC5 from 2017 to 2040. The boundary capability is currently a voltage compliance limit at 3.8GW for a double-circuit fault on the Bramford–Pelham and Bramford–Braintree–Rayleigh Main circuits.

The growth in offshore wind and nuclear generation capacities connecting behind this boundary greatly increases the transfer capability requirements. This is particularly prominent with the **Gone Green** scenario.

The present boundary capability is sufficient for today’s needs but potentially grossly short of the future capability requirement needs.

# The electricity transmission network

## 3.8 Network capability and requirements by region

### South of England boundaries

#### Introduction

The South of England transmission region includes boundaries B13, B14, LE1, SC1 and SC2. The region includes the high demand area of London, generation around the Thames estuary and the long set of circuits that run around the south coast. Interconnection to Central Europe

is connected along the south-east coast and this interconnection has significant influence on power flows in the region by being able to both import and export power with Europe. The figure below shows likely power flow directions in the years to come up to 2027. The arrows in the diagram are meant to give illustration to power flows but are not to scale.

**Figure 3.8**  
*South of England transmission network*

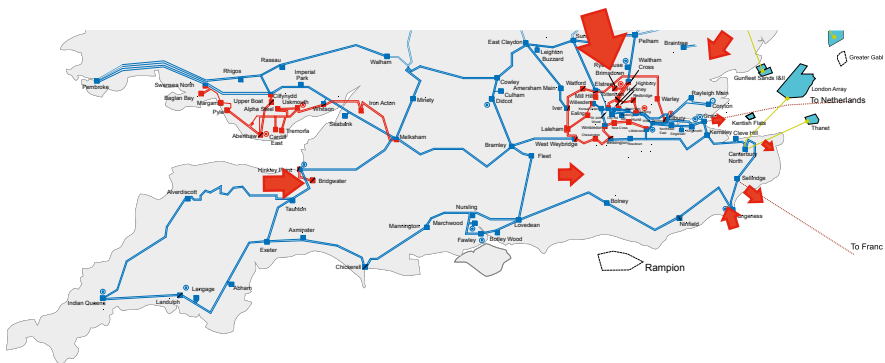

#### Primary challenge statement:

European interconnector developments along the south coast could potentially drive very high circuit flows causing circuit overloads, voltage management and stability issues.

#### Regional drivers

The future energy scenarios suggest that up to 13GW of capacity in the south could be from European interconnection and

energy storage. As interconnectors and storage are bi-directional, the south could see their capacity act as up to 13GW power injection or 13GW increased demand. This variation could place a very heavy burden on the transmission network. Most of the interconnectors will be connected south of boundary SC1 so the impact on them can be seen later in the chapter in the SC1 requirements.

**Figure SE.1**  
*Generation mix scenarios for the South of England*

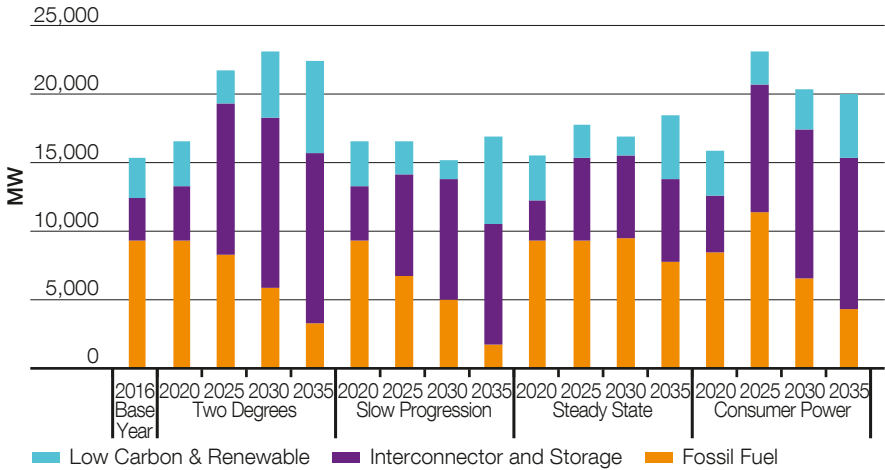

Peak demand in the south as seen by the transmission network is not expected to change significantly for most of the scenarios except for the **Consumer Power** scenario in which society's wealth allows them to

purchase more electric vehicles and heat pumps. The graph below shows snapshots of the peak demand for the south for the four different future energy scenarios.

# The electricity transmission network

**Figure SE.2**  
Demand scenarios for the South of England

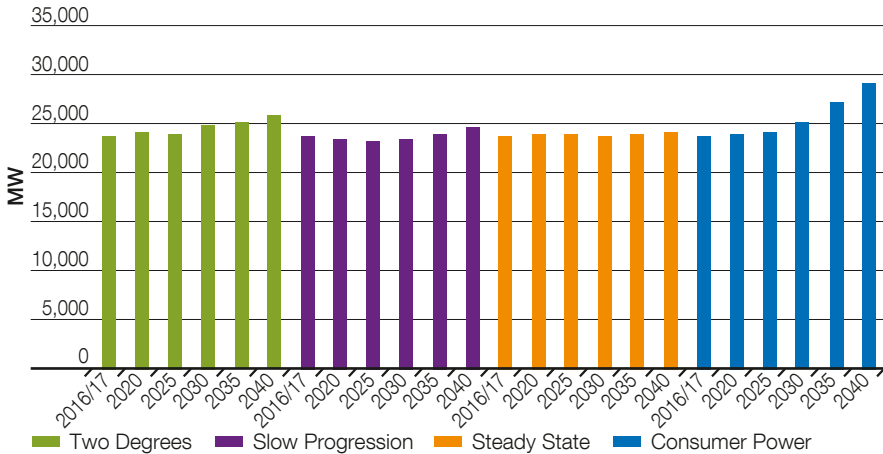

The transmission network in the south is heavily meshed in and around London (B14) and the Thames estuary, but below there and towards the west the network becomes more radial with relatively long distances between substations.

In the future, the southern network could potentially see a number of issues driven by future connections. If the interconnectors export power to Europe at the same time that high demand power is drawn both into and through London then the northern circuits feeding London will be thermally overloaded. The high demand and power flows may also lead to voltage depression in London and the south-east. The closure of conventional generation within the region will present added stability and voltage depression concerns which may need to be solved through reinforcements.

If the south-east interconnectors are importing from the continent and there is a double circuit fault south of Kemsley,

then the south-east circuits may overload and there could be significant voltage depression along the circuits to Lovedean.

With future additional interconnector connections, the south region will potentially be unable to support all interconnectors importing or exporting simultaneously without network reinforcement. Overloading can be expected on many of the southern circuits. The connection of the new nuclear generating units at Hinkley may also require reinforcing the areas surrounding Hinkley. With new interconnector and generation connections boundaries SC1, SC2, LE1 and B13 will need to be able to support large power flows in both directions, which is different from today when power flow is predominantly in one direction.

The NOA 2017/18 will assess the likelihood and impact of the above mentioned potential scenarios and accordingly recommend preferred reinforcements for the South of England transmission region.

## Boundary B13 – South West

*Figure B13.1*  
Geographic and single-line representation of boundary B13

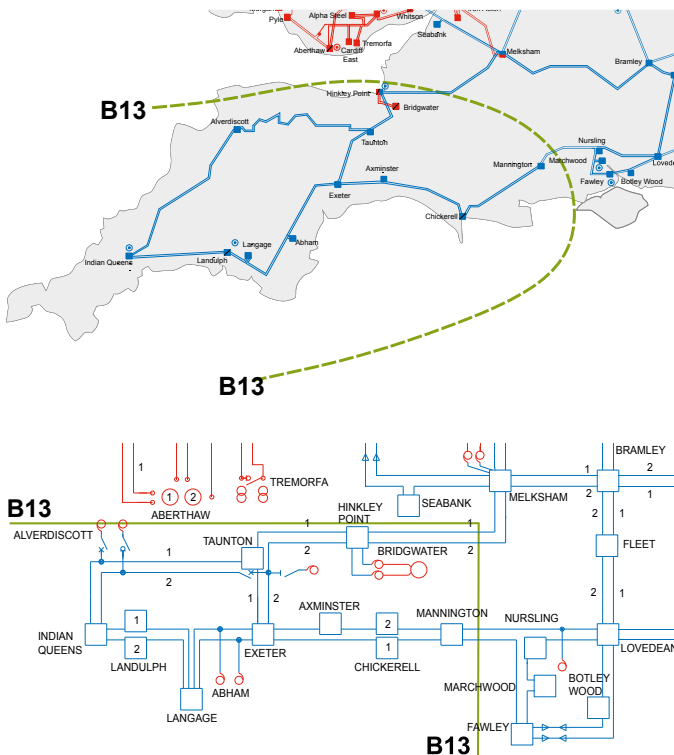

Wider boundary B13 is defined as the southernmost tip of the UK below the Severn Estuary, encompassing Hinkley Point in the south-west and stretching as far east as Mannington. The boundary-crossing circuits are the Hinkley Point to Melksham double circuit and the Mannington circuits to Nursling and Fawley. The south-west peninsula is a region with a high level of localised generation

and demand. The boundary is currently an importing boundary, with the demand being higher than the generation at peak demand conditions. With the potential connection of new generation and interconnectors to the south-west – including new nuclear and wind generation – the boundary is expected to change to export power more often than import.

# The electricity transmission network

**Figure B13.2**  
Required transfer and base capability for boundary B13

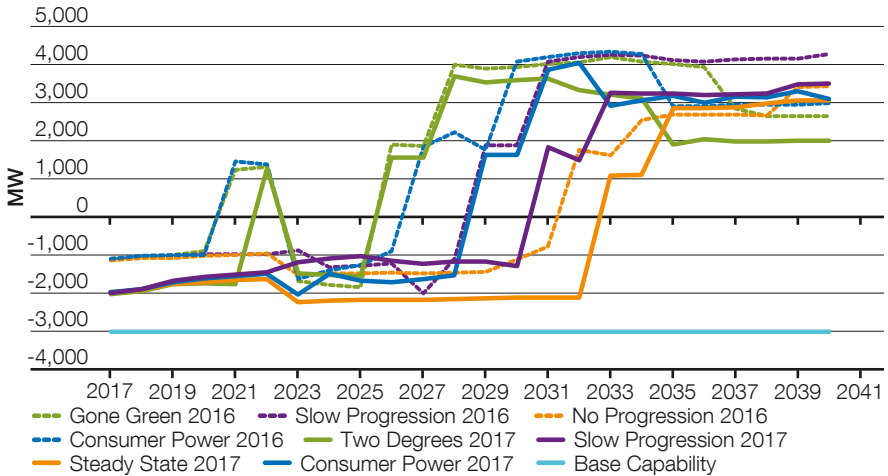

### Boundary requirements and capability

Figure B13.2 above shows the required transfers for boundary B13 from 2017 to 2040. The boundary capability is voltage collapse limit at 3.0GW for a double-circuit fault on the Axminster–Exeter and Chickerell–Exeter circuits.

It can be seen that until new generation or interconnectors connect there is very little variation in boundary requirements, and that the current importing boundary capability is sufficient to meet the short-term needs. The large size of the potential new generators wishing to connect close to boundary B13 is likely to push it to large exports and require additional boundary capacity.



## Boundary B14 – London

*Figure B14.1*  
Geographic and single-line representation of boundary B14

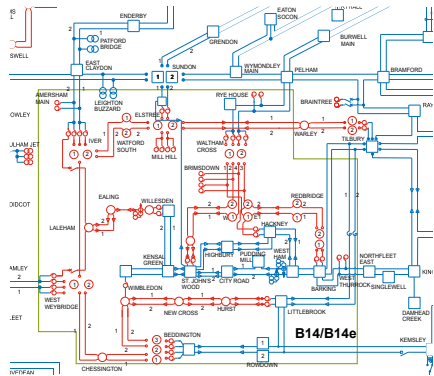
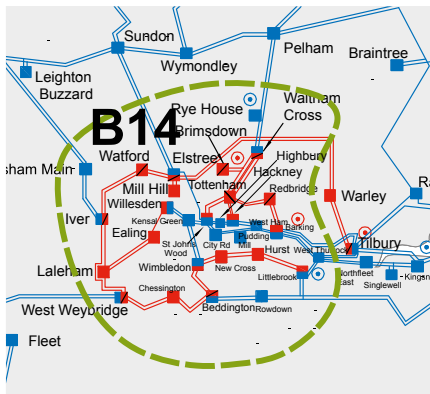

Boundary B14 encloses London and is characterised by high local demand and a small amount of generation. London’s energy import relies heavily on surrounding 400kV and 275kV circuits. The circuits entering from the north can be particularly heavily loaded at winter peak conditions. The circuits are further

stressed when the European interconnectors export as power is drawn through London to feed the interconnectors along the south coast. The North London circuits can also be a bottleneck for power flow from the East Coast and East Anglia regions as power flows through London north to south.

# The electricity transmission network

**Figure B14.2**  
 Required transfer and base capability for boundary B14

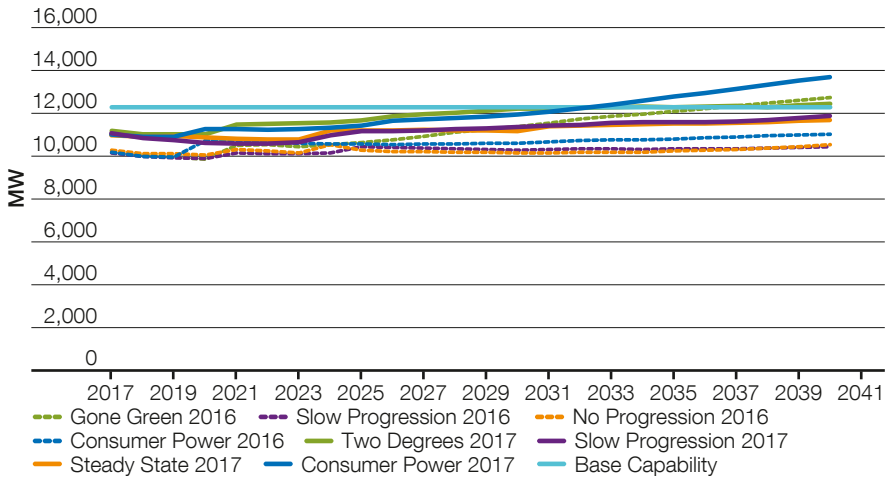

### Boundary requirements and capability

Figure B14.2 above shows the required transfers for boundary B14 from 2017 to 2041. The boundary capability is currently limited by thermal constraints at 12.2GW for a double-circuit fault on the Pelham–Rye House–Waltham Cross circuits.

As the transfer across this boundary is mostly dictated by the contained demand, the scenario requirements mostly follow the demand with little deviation due to generation changes.

The **Slow Progression** scenario shows a lower boundary requirement than **Two Degrees** as the few conventional plants within the boundary are expected to continue operation in that scenario.

Our scenarios consider that during peak demand conditions the GB power system may export electricity to mainland Europe. This alleviates loading stress on the North London circuits as additional power is required to be transported towards the south coast across London to feed the interconnectors. This increases the north London circuits loading, which decreases the boundary capability as less circuit capacity remains to supply London demand.

## Boundary SC1 – South Coast

*Figure SC1.1*  
Geographic representation of boundary SC1

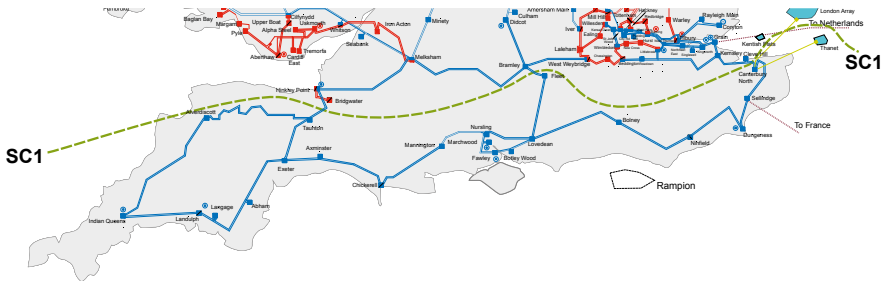

The South Coast boundary SC1 runs parallel with the south coast of England between the Severn and Thames estuaries. At times of peak winter GB demand the power flow is typically north to south across the boundary, with more demand enclosed in the south of the boundary than supporting generation.

Interconnector activity can significantly influence the boundary power flow. The current interconnectors to France and the Netherlands connect at Sellindge and Grain respectively. Crossing the boundary are three 400kV double circuits with one in the east, one west and one in the middle between Fleet and Bramley.

# The electricity transmission network

**Figure SC1.2**  
*Required transfer and base capability for boundary SC1*

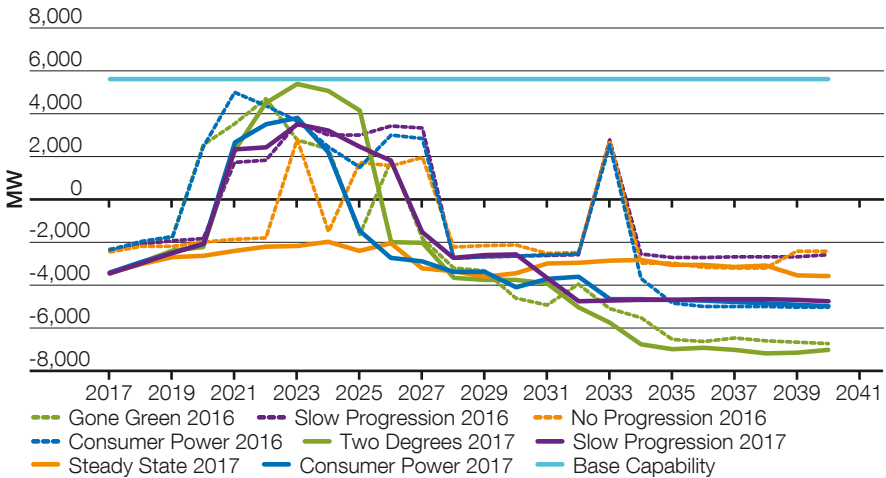

### Boundary requirements and capability

Figure SC1.2 above shows the required transfers produced from the 2017 future energy scenarios for boundary SC1 from 2016 to 2040. Positive values represent power flow across the boundary from north to south. The boundary capability is currently limited by thermal loading at 5.6GW for a double-circuit fault on the Bramley–Didcot circuits.

The volatility of interconnector activity can be seen in the required transfers as the requirements swing from power flow south and north. The SQSS calculation of required transfers does not place high loading on the interconnectors so the transfers are not seen to peak at very high values. Credible sensitivities of the interconnectors operating at their rated capacities suggest that boundary power transfers could exceed 10GW which is well outside current network capability.

The interconnectors to Europe have a massive impact on the power transfers across SC1. A 2GW interconnector such as IFA can make 4GW of difference on the boundary if it moves from importing power to export. Some of the future energy scenarios suggest that up to 15GW of interconnector capacity could connect below SC1 by 2030.

## Boundary SC2 – South East Coast

*Figure SC2.1*  
Geographic representation of boundary SC2

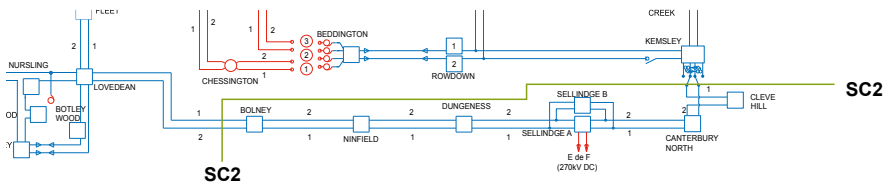
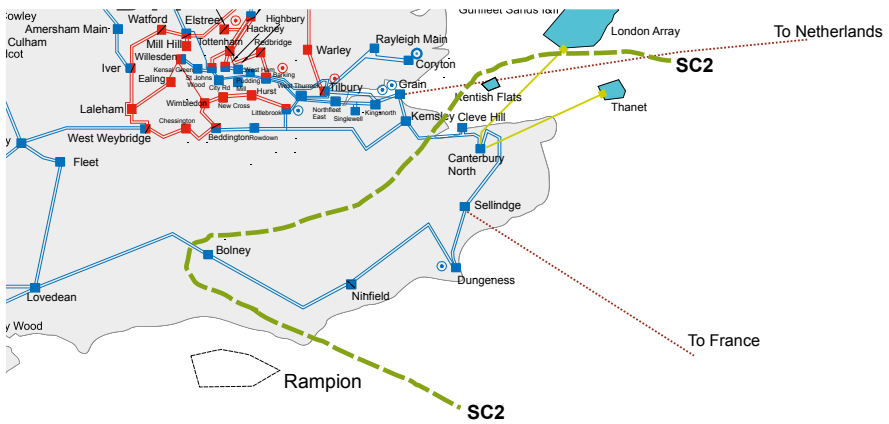

The new South East Coast boundary SC2 is a subset of the SC1 boundary created to capture transmission issues specifically in the south part of the network between Kemsley and Lovedean. The relatively long 400kV route between Kemsley and Lovedean feeds significant demand and connects both large generators and interconnection to Europe.

A fault at either end of the route can cause it to become a long radial feeder which puts all loading on the remaining two circuits which can be restrictive due to circuit ratings and cause voltage issues.

Additional generation and interconnectors are contracted for connection below SC2 which can place additional burden on the region.

# The electricity transmission network

**Figure SC2.2**  
 Required transfer and base capability for boundary SC2

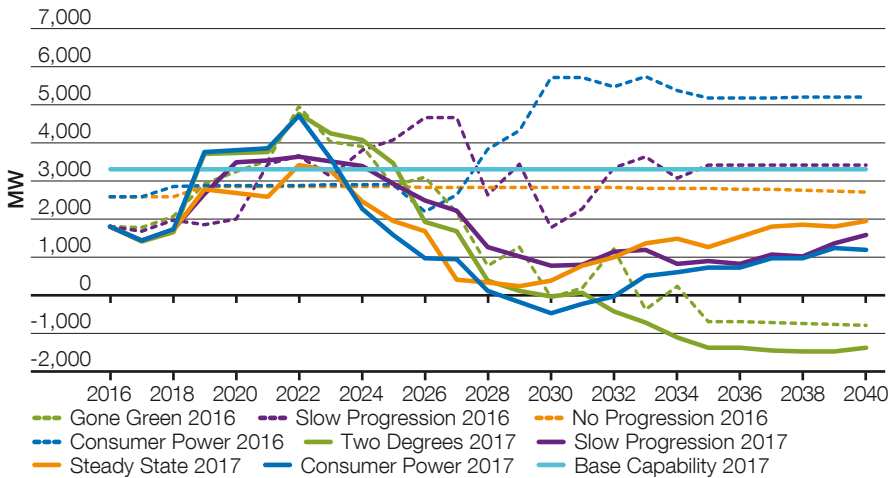

### Boundary requirements and capability

Figure SC2.2 above shows the required transfers for boundary SC2 from 2017 to 2040. Positive values represent exporting power flows out of the south-east area enclosed by the boundary. The boundary capability is currently voltage stability limited at 3.3GW.

The interconnectors with Europe have a massive impact on the power transfers across SC2 as a 2GW interconnector can make 4GW of difference on the boundary if it moves from import to export. The future energy scenarios suggest that up to 5.4GW of interconnector capacity could connect below SC1 by 2026.

The volatility of interconnector activity can be seen in the required transfers as the requirements move around significantly. The SQSS calculation of required transfers does not place high loading on the interconnectors so the transfers are not seen to peak at very high values. Credible sensitivities of the interconnectors operating at their rated capacities suggest that boundary power transfers could exceed 6GW which is well outside current network capability.

## Boundary LE1 – South-east

*Figure LE1.1  
Geographic and single-line representation of boundary LE1*

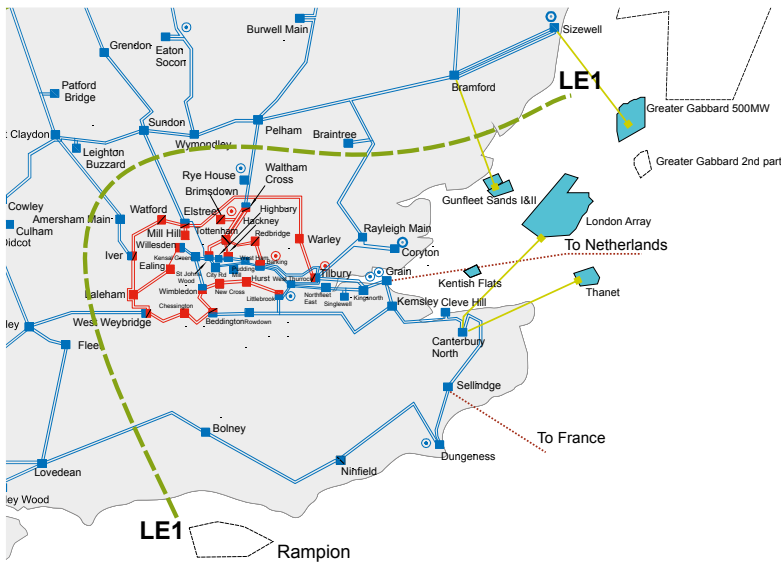

Boundary LE1 encompasses the south-east part of the UK, incorporating London and the areas to the south and east of it. This stretches as far as the Eastern extremities of Hampshire in the south-west. LE1 is characterised by two distinct areas. Within London there is high local demand, and relatively small levels of generation. The south-east part contains both high demand and relatively high levels of generation, particularly the gas power generation in the Thames Estuary area. In addition, there are several current and potential future interconnectors to France, Belgium and the Netherlands located around the coast. In general, with interconnectors importing power from the continent, power flows enter

London from all directions, and while LE1 overall almost exclusively imports from the north and west, the extent of this is within the boundary capability and no other constraints are seen other than those shown by B14, B15 or the south coast boundaries. However, with increased number of interconnectors and likelihood of them exporting power in future years, LE1 can become a high demand area, with any locally generated power feeding straight into the interconnectors. As such, the circuits entering from the north can become overloaded as power is drawn into and through London toward the south and east. Thus the boundary is only of relevance during interconnector exporting conditions.

# The electricity transmission network

**Figure LE1.2**  
Required transfer and base capability for boundary LE1

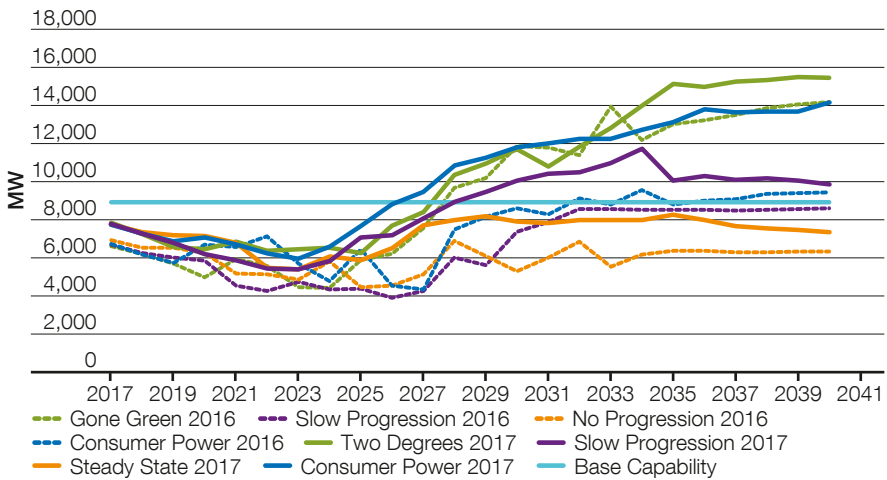

### Boundary requirements and capability

Figure LE1.2 above shows the required transfers for boundary LE1 from 2017 to 2040. The boundary capability is currently limited by thermal constraints at 8.9GW with overloads of the Rayleigh Main–Tilbury circuits.

As the transfer across this boundary is mostly dictated by the contained demand and interconnector power flow, the scenario requirements mostly follow those with little deviation due to generation changes.

The **Slow Progression** and **Steady State** scenarios show a lower boundary requirement than **Two Degrees** and **Consumer Power**.

Our scenarios consider that during peak demand conditions the GB power system may export electricity to mainland Europe. This introduces loading stress on the North London circuits also voltage constraint around the south-east region as additional power is required to be transported towards the south coast across London to feed the interconnectors.



# Chapter four

---

The way forward

96

---

# The way forward

---

The evolution of the *ETYS* and *NOA* processes continues in line with changes within the industry, such as the Integrated Transmission Planning and Regulation (ITPR) and the Future of the SO (FSO) programme. We also welcome and endeavour to use any feedback we receive from you, our stakeholders.

---

## 4.1 The *ETYS* 2017 and *NOA* 2017/18 under the ITPR arrangement

The ITPR, implemented by Ofgem, is an arrangement aimed at improving the long-term planning of the onshore, offshore and cross-border electricity transmission network. The two key objectives of ITPR are that:

- the network is planned in an economic and efficient way, and
- asset delivery is efficient and consumers are protected from undue costs and risk.

You can find more information about this arrangement [here](#).

As a part of the ITPR planning process, the *ETYS* provides indication of long-term transmission requirements. The TOs use this information as guidelines to propose network development options to satisfy future requirements. Following this, the *NOA* report recommends which options should proceed, not proceed or delay.

---

## 4.2 The FSO programme and the *ETYS*

**Through the FSO programme, we're transitioning to a more independent electricity system operator (ESO) within National Grid Group. This will shape the future development of the *ETYS* and *NOA* publications, as we look to improve our recommendations for reinforcements for the benefit of our customers and consumers.**

In January this year, Ofgem called for greater separation between the SO and TO roles. In response, we've been rolling out the new FSO programme.

Under the FSO programme, one of the things we are working on is transforming our network development capability. This aims to find the best value for consumers and to lay the foundations for future competition.

We will be looking to encourage and assess a broad range of solutions to meet long-term transmission needs. To do this, we will need to look beyond traditional asset-based transmission network solutions and further

build commercial and technical solutions – this may include working with distribution network owners (DNOs) and other parties. Driven by the large penetration of intermittent generation, we are developing probabilistic tools with feedback from the industry and TOs to support our planning studies. This includes year-round assessments, as well as looking at how best to present our results to the wider audience.

The intention is to discuss with the regulator, Ofgem and stakeholders how best to use the *ETYS* and the *NOA* report as a way to facilitate communication to stakeholders about the future development, opportunities and challenges in the NETS.

# The way forward

## 4.3 Stakeholder feedback

We would like to hear your views on how we should shape both *ETYS* and *NOA* documents to satisfy your needs. An indicative timetable for our 2017 and 2018 *ETYS/NOA* stakeholder activities programme is shown below.

**Figure 4.1**  
*ETYS/NOA stakeholder activities programme*

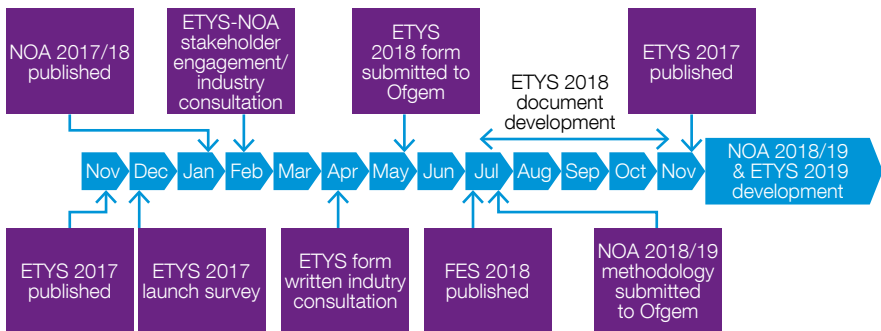

We welcome your views on this year's *ETYS*, and would like to know what you think works well and what you would like us to improve. Please complete our survey at [www.surveymonkey.com/r/ETYS2017](http://www.surveymonkey.com/r/ETYS2017) and take part in our written consultation (planned for April 2018 for *ETYS*). Our various stakeholder activities are a great way for us to:

- learn more about the views and opinions of all our stakeholders
- provide opportunities for constructive feedback and debate
- create open, two-way communication with our stakeholders about assumptions, analyses and findings and
- let stakeholders know how we have taken their views into consideration and the outcomes of our engagement activities.

We are always happy to listen to our stakeholders' views. We do this through:

- consultation events as part of the customer seminars
- operational forums
- responses to [transmission.etyts@nationalgrid.com](mailto:transmission.etyts@nationalgrid.com), and
- bilateral stakeholder meetings.

# Chapter five

---

Appendices overview	100
Meet the <i>ETYS</i> team	102
Glossary	104
Disclaimer	109

---

# Appendix overview

---

## Appendix A

### System schematics and geographic drawings

Appendix A includes a set of system schematics and geographic drawings of the current NETS, with the approximate locations of existing power stations and reactive compensation plants shown. The schematics also show the NETS boundaries and ETYS zones we have used in our analysis.

You can view the system schematics at: <https://www.nationalgrid.com/uk/publications/electricity-ten-year-statement-etys>

You can view the geographic drawings at: <https://www.nationalgrid.com/uk/publications/electricity-ten-year-statement-etys>

## Appendix B

### System technical data

To allow modelling of the transmission network, basic network parameters such as connectivity and impedances are provided in appendix B. The expected changes in the network based on the previous year's development decisions are also provided.

You can view the system technical data at: <https://www.nationalgrid.com/uk/publications/electricity-ten-year-statement-etys>

## Appendix C

### Power flow diagrams

To demonstrate the impact of future changes on the transmission network a set of winter peak power flow diagrams are presented in appendix C. These show snapshots of present and future power flows along major circuit routes for the **Gone Green** scenario. The expected changes in the network are based on the previous year's development decisions.

You can view the diagrams at: <https://www.nationalgrid.com/uk/publications/electricity-ten-year-statement-etys>

---

## Appendix D

### Fault levels

Appendix D gives indications of peak GB fault levels at nodal level for the current and future transmission network. The fault levels are at peak generation and demand conditions and can be used to investigate local area system strength.

You can find out more at:

<https://www.nationalgrid.com/uk/publications/electricity-ten-year-statement-etys>

You can view the fault level data at:

<https://www.nationalgrid.com/uk/publications/electricity-ten-year-statement-etys>

---

## Appendix E

### Data and charts workbook

This appendix contains data and charts relating to national and/or regional National Electricity Transmission System (NETS) information about:

- energy storage and interconnectors
- summer minimum demand
- embedded generation.

You can find out more at:

<https://www.nationalgrid.com/uk/publications/electricity-ten-year-statement-etys>

## Meet the *ETYS* team

---

---

### **Julian Leslie**

Head of Network Capability (Electricity)

[Julian.Leslie@nationalgrid.com](mailto:Julian.Leslie@nationalgrid.com)

### **Nicholas Harvey**

Network Development Manager

[Nicholas.Harvey@nationalgrid.com](mailto:Nicholas.Harvey@nationalgrid.com)

### **Graham Stein**

Network Operability Manager

[Graham.Stein@nationalgrid.com](mailto:Graham.Stein@nationalgrid.com)

### **Lauren Moody**

Data and Modelling Manager

[Lauren.Moody@nationalgrid.com](mailto:Lauren.Moody@nationalgrid.com)

---

## Network development

In addition to publishing the *ETYS* we are responsible for developing a holistic strategy for the NETS. This includes performing the following key activities:

- The management and implementation of the *Network Options Assessment (NOA)* process in order to assess the need to progress wider transmission system reinforcements.
- Producing recommendations on preferred options for NETS investment under the new ITPR arrangements and publishing results annually in the *NOA* report.

You can contact us to discuss about:

Network requirements and *Electricity Ten Year Statement*

### **Richard Proctor**

GB System Capability Manager

[Richard.Proctor@nationalgrid.com](mailto:Richard.Proctor@nationalgrid.com)

Cost-benefit analysis and *Network Options Assessment*

### **Hannah Kirk-Wilson**

Technical and Economic Assessment Manager

[Hannah.Kirk-Wilson@nationalgrid.com](mailto:Hannah.Kirk-Wilson@nationalgrid.com)



---

## Network operability and data & modelling

In our Network Operability department, we are responsible for studying a variety of power system issues including generator and HVDC compliance. We develop and produce the System Operability Framework (SOF). From our Data and Modelling department we produce power system models and datasets for network analysis. We also manage the technical aspects of the GB and European electricity frameworks, codes and standards that are applicable to network development.

Contact details to discuss the network data used in *ETYS*:

**Stuart Boyle**  
System Modelling Manager  
[Stuart.Boyle@nationalgrid.com](mailto:Stuart.Boyle@nationalgrid.com)

Contact details to discuss the SOF:

**Elizabeth Warnock**  
Smarter Performance Manager  
[Elizabeth.Warnock@nationalgrid.com](mailto:Elizabeth.Warnock@nationalgrid.com)

---

## Supporting parties

Strategic network planning and producing the *ETYS* requires support and information from many people. Parties who provide support and information that makes our work possible includes;

- National Grid Electricity Transmission Owner
- The GB Transmission Owners in Scotland
- Our customers.

Don't forget you can also email us with your views on *ETYS* at: [transmission.ety@nationalgrid.com](mailto:transmission.ety@nationalgrid.com)

You can also join our mailing list to receive *ETYS* email updates at the following link and look for the Enquiries section: <https://www.nationalgrid.com/uk/publications/electricity-ten-year-statement-ety>

# Glossary

Word	Acronym	Description
2050 carbon reduction target		UK commitment to reduce carbon emissions by at least 80 per cent from 1990 levels by 2050.
Aggregator		A party who acts on behalf of a number of smaller energy consumers or producers to derive value from their resources. For example, an aggregator could be given control over a number of households' energy appliances, and sell this resource into different flexibility markets where the ability to turn this large number of appliances up and down is valuable from a system operation perspective.
Air source heat pump	ASHP	Air source heat pumps absorb heat from the outside air. This heat can then be used to produce hot water or space heating.
Anaerobic digestion	AD	Bacterial fermentation of organic material in the absence of free oxygen.
Ancillary services		Services procured by a System Operator to balance demand and supply and to ensure the security and quality of electricity supply across the transmission system. These services include reserve, frequency control and voltage control. In GB these are known as Balancing Services and each service has different parameters that a provider must meet.
Autonomous vehicle		A vehicle that is capable of driving without human input.
Balgzand Bacton Line	BBL	A gas pipeline between Balgzand in the Netherlands and Bacton in the UK.
Behind the meter generation		Onsite generation that is connected before a customer's meter and therefore can provide electricity for consumption onsite without this power being metered on the distribution or transmission network.
Billion cubic metres	bcm	Unit of measurement of volume, used in the gas industry. 1 bcm = 1,000,000,000 cubic metres.
Biomethane		A naturally occurring gas that is produced from organic material and has similar characteristics to natural gas.
Biosubstitute natural gas	BioSNG	Pipeline quality gas created from waste.
Capacity Market	CM	The Capacity Market is designed to ensure security of electricity supply. This is achieved by providing a payment for reliable sources of capacity, alongside their electricity revenues, ensuring they deliver energy when needed.
Carbon capture and storage	CCS	A process by which the CO <sub>2</sub> produced in the combustion of fossil fuels is captured, transported to a storage location and isolated from the atmosphere. Capture of CO <sub>2</sub> can be applied to large emission sources like power plants used for electricity generation and industrial processes. The CO <sub>2</sub> is then compressed and transported for long-term storage in geological formations or for use in industrial processes.
Carbon dioxide	CO <sub>2</sub>	The main greenhouse gas. The vast majority of CO <sub>2</sub> emissions come from the burning of fossil fuels.
Carbon price floor	CPF	A price paid by UK generators and large carbon intensive industries for CO <sub>2</sub> emissions.
Combined cycle gas turbine	CCGT	A combustion turbine that uses natural gas or liquid fuel to drive a generator to generate electricity. The residual heat from this process is used to produce steam in a heat recovery boiler which, in turn, drives a steam turbine generator to generate more electricity.
Combined heat and power	CHP	A system where both heat and electricity are generated simultaneously as part of one process. Covers a range of technologies that achieve this.
Contract for Difference	CfD	A contract between the Low Carbon Contracts Company (LCCC) and a low carbon electricity generator, designed to reduce its exposure to volatile wholesale prices.
Decentralised generation		Electricity generation that is connected to power networks below the high voltage transmission system. Includes distributed generation and onsite generation.
Demand side response	DSR	A deliberate change to a user's natural pattern of metered electricity or gas consumption, brought about by a signal from another party.

Word	Acronym	Description
Department for Business, Energy and Industrial Strategy	BEIS	UK Government department with responsibilities for business, industrial strategy, science, innovation, energy and climate change.
Dispatch (also economic dispatch)		The selection of generating capacity in order of increasing marginal cost, within the bounds of network and other operational constraints.
Distributed generation		Generation connected to the distribution networks, the size of which is equal or greater than 1 MW and up to the mandatory connection thresholds of the onshore transmission areas. The thresholds are 100MW in NGET transmission area, 30MW in Scottish Power (SP) transmission area and 10MW in Scottish Hydro-Electric Transmission (SHEI) transmission area.
Distribution Network Operator	DNO	A company that owns and operates gas or electricity distribution networks.
Electric vehicle	EV	A vehicle powered by an electric motor. It can either be driven solely off a battery, as part of a hybrid system or have a generator that can recharge the battery but does not drive the wheels. We only consider EVs that can be plugged in to charge in this report.
<i>Electricity Ten Year Statement</i>	<i>ETYS</i>	A document published by the System Operator which illustrates the potential future development of the National Electricity Transmission System (NETS) over a ten-year (minimum) period and is published on an annual basis.
Electricity Transmission Licence	ETL	A permit which allows transmission companies to own and operate electricity transmission assets. Conditions within the licence place rules on how holders can operate within their licence.
European Union	EU	A political and economic union of 28 member states that are located in Europe.
Feed-in tariffs	FIT	A government programme designed to promote the uptake of a range of small-scale renewable and low carbon electricity generation technologies.
Frequency response		An ancillary service procured by National Grid as System Operator to help ensure system frequency is kept as close to 50 Hz as possible. Also known as frequency control or frequency regulation.
Frequently asked questions	FAQ	A list of questions and answers.
Fuel cell		An electrochemical device that converts chemical energy from fuel into electricity.
Fuel cell vehicle	FCV	A vehicle powered by a fuel cell using hydrogen as fuel.
<i>Future Energy Scenarios</i> (publication)	<i>FES</i>	<i>FES</i> contains a range of credible futures which have been developed in conjunction with the energy industry. They are a set of scenarios covering the period from now to 2050, and are used to frame discussions and perform stress tests. They form the starting point for all transmission network and investment planning, and are used to identify future operability challenges and potential solutions.
<i>Future Energy Scenarios in five minutes</i>	<i>FES in 5</i>	A summary version of <i>FES</i> .
Gas absorption heat pump	GAHP	A heat pump powered by natural gas rather than electricity.
Gas day		The period from 5:00 to 5:00 UTC the following day for winter time and from 4:00 to 4:00 UTC the following day when daylight saving is applied. Gas flows into and out of the NTS have to balance over a gas day.
<i>Gas Ten Year Statement</i>	<i>GTYS</i>	A document published by the System Operator which illustrates the potential future development of the (gas) National Transmission System (NTS) over a ten-year period and is published on an annual basis.
Gigawatt	GW	1,000,000,000 watts, a unit of power.
Gigawatt hour	GWh	1,000,000,000 watt hours, a unit of energy.
Gram of carbon dioxide per kilowatt hour	gCO <sub>2</sub> /kWh	Measurement of CO <sub>2</sub> equivalent emissions per kWh of energy used or produced.

# Glossary

Word	Acronym	Description
Great Britain	GB	A geographical, social and economic grouping of countries that contains England, Scotland and Wales.
Green Deal		A scheme that provided financial support to individuals and businesses to make energy efficiency improvements to their buildings. Now discontinued.
Green gas		A term used to describe low carbon gas. In the 2017 FES this category includes biomethane and bioSNG.
Gross domestic product	GDP	The total market value of all goods and services produced in a country in a given year. This is equal to total consumer, investment and government spending, plus the value of exports, minus the value of imports.
Ground source heat pump	GSHP	Heat pumps which absorb heat from the ground. This heat can then be used to produce hot water or space heating.
Heat pump		A device that transfers heat energy from a lower temperature source to a higher temperature destination.
Heavy goods vehicle	HGV	A truck weighing over 3,500 kg.
Industrial and commercial	I&C	A category used for aggregating energy demand, based on the Standard Industrial Classification (SIC (2007)).
Information communication technology	ICT	Includes computing and digital communication.
Interconnector (UK)	IUK	A bi-directional gas pipeline between Bacton in the UK and Zeebrugge Belgium.
Interconnector		Transmission assets that connect the GB market to Europe and allow suppliers to trade electricity or gas between markets.
Internal combustion engine	ICE	An engine powered by petrol, diesel or gas. Used in FES to refer to engines powering vehicles.
Liquefied natural gas	LNG	Formed by chilling natural gas to -161°C to condense as a liquid. Its volume reduces 600 times from the gaseous form.
Load Factor		The average power output divided by the peak power output over a period of time.
Loss of load expectation	LoLE	Used to describe electricity security of supply. It is an approach based on probability and is measured in hours/year. It measures the risk, across the whole winter, of demand exceeding supply under normal operation. This does not mean there will be loss of supply for 3 hours per year. It gives an indication of the amount of time, across the whole winter, which the System Operator (SO) will need to call on balancing tools such as voltage reduction, maximum generation or emergency assistance from interconnectors. In most cases, loss of load would be managed without significant impact on end consumers.
Marine technologies		Tidal streams, tidal lagoons and energy from wave technologies.
Medium range storage	MRS	Gas storage facilities designed to switch rapidly between injection and withdrawal to maximise the value from changes in gas price.
Megawatt (electrical)	MWe	1,000,000 watts, a unit of electrical power.
Megawatt hour	MWh	1,000,000 watts hours, a unit of energy.
Micro-combined heat and power	mCHP	A subset of CHP, designed for domestic use.
Million cubic meters	mcm	A unit or measurement of volume, used in the gas industry. 1 mcm = 1,000,000 cubic metres.
N-1		Condition used in a security of supply test, where total supply minus the largest single loss is assessed against total peak demand.
National Transmission System	NTS	A high-pressure gas transportation system consisting of compressor stations, pipelines, multijunction sites and offtakes. NTS pipelines transport gas from terminals to NTS offtakes and are designed to operate up to pressures of 94 barg.
Natural gas vehicle	NGV	A vehicle which uses compressed or liquefied natural gas as an alternative to petrol or diesel.

Word	Acronym	Description
Office of Gas and Electricity Markets	Ofgem	The independent National Regulatory Authority in GB; a non-ministerial government department. Their principal objective is to protect the interests of existing and future electricity and gas consumers.
Open cycle gas turbine	OCGT	A combustion turbine plant fired by gas or liquid fuel to turn a generator rotor that produces electricity.
Peak demand, electricity		The maximum electricity demand in any one fiscal year. Peak demand typically occurs at around 5:30pm on a week-day between November and February. Different definitions of peak demand are used for different purposes.
Peak demand, gas		The level of demand that, in a long series of winters, with connected load held at levels appropriate to the winter in question, would be exceeded in one out of 20 winters, with each winter counted only once.
Photovoltaic	PV	A method of converting solar energy into direct current electricity using semiconducting materials.
Plug-in hybrid electric vehicle	PHEV	A vehicle which has a battery that can be charged by plugging it in, as well as a combustion engine.
Political, Economic, Social, Technological and Environmental	PESTE	A framework used to analyse and monitor the macro-environmental factors that have an impact on an organisation.
Pure electric vehicle	PEV	A vehicle powered only by a battery.
Renewable Heat Incentive	RHI	A payment incentive administered by Ofgem which pays owners of certain renewable heating technologies per unit of heat produced. There is a domestic and a non-domestic version.
Renewables Obligation	RO	A support mechanism for renewable electricity projects in the UK. It places an obligation on UK electricity suppliers to source an increasing proportion of the electricity they supply from renewable sources.
Repowering		Re-fitting a generation site with new equipment such as new wind turbine blades so that it can continue to generate electricity, usually more efficiently than previously.
Seasonal storage or long range storage	LRS	A gas storage facility which mainly puts gas into storage in the summer and takes gas out of storage in the winter. There was one long-range storage site on the national transmission system: Rough, situated off the Yorkshire coast. Rough was formally closed in June 2017.
Shale gas		A natural gas that is found in shale rock. It is extracted by injecting water, sand and chemicals into the shale rock to create cracks or fractures so that the shale gas can be extracted.
Shared vehicle		A vehicle that fulfils the transportation requirements of more than one person.
Small modular reactor		Nuclear reactors, generally 300MWe equivalent or less, designed with modular technology using module factory fabrication.
Smart appliances		Residential electricity-consuming goods which are able to reduce their demand at defined times of the day, either by reacting to a signal or by being programmed.
Smart charging		Charging units which have two-way communication ability and that can react to external signals.
Smart meter		New generation gas and electricity meters which have the ability to broadcast secure usage information to customers and energy suppliers, potentially facilitating energy efficiency savings and more accurate bills.
Space heating		Heating an enclosed area.
Steam Methane Reforming	SMR	A method for producing hydrogen, carbon monoxide, or other useful products from hydrocarbon fuels such as natural gas.
System operability		The ability to maintain system stability and all of the asset ratings and operational parameters within pre-defined limits safely, economically and sustainably.

# Glossary

---

<b>Word</b>	<b>Acronym</b>	<b>Description</b>
System Operator	SO	An entity entrusted with transporting energy in the form of natural gas or electricity at a regional or national level, using fixed infrastructure. The SO may not necessarily own the assets concerned. For example, National Grid operates the electricity transmission system in Scotland, which is owned by Scottish Hydro Electricity Transmission and Scottish Power.
Terawatt hour	TWh	1,000,000,000,000 watt hours, a unit of energy.
Time-of-use tariff	TOU	A charging system that is established in order to incentivise residential consumers to alter their consumption behaviour, usually away from high electricity demand times.
UK Continental Shelf	UKCS	Comprised of those areas of the sea bed and subsoil beyond the territorial sea over which the UK exercises sovereign rights of exploration and exploitation of natural resources.
Unabated coal		Coal-fired electricity generation that is not fitted with carbon capture and storage.
United Kingdom of Great Britain and Northern Ireland	UK	A geographical, social and economic grouping of countries that contains England, Scotland, Wales and Northern Ireland.

# Disclaimer

---

The information contained within the Electricity Ten Year Statement document ("the Document") is disclosed voluntarily and without charge. The Document replaces the Seven Year Statement (SYS) and the Offshore Development Information Statement (ODIS) and is published in accordance with the relevant Licence conditions.

National Grid would wish to emphasise that the information must be considered as illustrative only and no warranty can be or is made as to the accuracy and completeness of the information contained within this Document. Neither National Grid Electricity Transmission, National Grid Gas nor the other companies within the National Grid group, nor the directors, nor the employees of any such company shall be under any liability for any error or

misstatement or opinion on which the recipient of this Document relies or seeks to rely other than fraudulent misstatement or fraudulent misrepresentation and does not accept any responsibility for any use which is made of the information or Document which or (to the extent permitted by law) for any damages or losses incurred. Copyright National Grid 2017, all rights reserved.

No part of this Document or this site may be reproduced in any material form (including photocopying and restoring in any medium or electronic means and whether or not transiently or incidentally) without the written permission of National Grid except in accordance with the provisions of the Copyright, Designs and Patents Act 1988.

## Copyright

Any and all copyright and all other intellectual property rights contained in this outlook document belong to National Grid. To the extent that you re-use the outlook document, in its original form and without making any modifications or adaptations thereto, you must reproduce, clearly and prominently, the following copyright statement in your own documentation:  
© National Grid plc, all rights reserved.

## Continuing the conversation

---

Email us with your views on *FES* or any of our future of energy documents at: [transmission.ukfes@nationalgrid.com](mailto:transmission.ukfes@nationalgrid.com) and one of our experts will get in touch.

Access our current and past *FES* documents, data and multimedia at: <https://www.nationalgrid.com/uk/publications/future-energy-scenarios-fes>

Get involved in the debate on the future of energy and join our LinkedIn group Future of Energy by National Grid.

**Write to us at:**  
Energy Insights  
National Grid House  
Warwick Technology Park  
Gallows Hill  
Warwick  
CV34 6DA





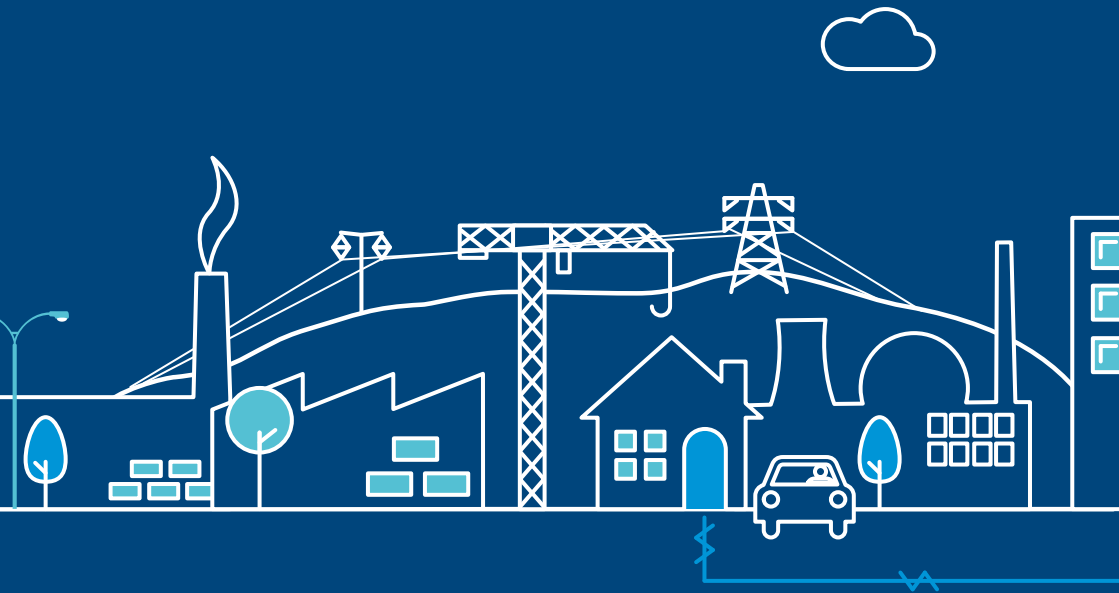

**National Grid plc**  
National Grid House,  
Warwick Technology Park,  
Gallows Hill, Warwick.  
CV34 6DA United Kingdom  
Registered in England and Wales  
No. 4031152